

TABLE OF CONTENTS

FOOD SERVICE ROLL FOIL	4
• HANDI-FOIL® FOOD SERVICE ROLL FOIL	
• MEDALLION® FOOD SERVICE ROLL FOIL	
INTERFOLDED FOIL SHEETS	5
• HANDI-FOIL® INTERFOLDED FOIL SHEETS	
• MEDALLION® INTERFOLDED FOIL SHEETS	
FOOD SERVICE FILM	5
• HANDI-FILM®	
HANDI-LOCK® CLEAR PLASTIC HINGED CONTAINERS	6
SENIOR & SCHOOL FEEDING	6
STEAM TABLES	7
GOURMET - TO - GO®	8 - 9
CATERING TRAYS	8 - 9
OBLONGS	10 - 11
LOAVES	10 - 11
ROUNDS	12 - 13
DANISH	12 - 13
PIES	14
MUFFINS	14
SQUARES/CAKES	15
ANGEL FOODS	15
SHEET CAKES	16
SEASONAL	16
ROASTERS	17
SPECIALTY	18
RETAIL CATERING	19
RETAIL ROLL FOIL	20
• HANDI-FOIL® ROLL FOIL	
• JIFFY-FOIL® ROLL FOIL	
• WRAP UPS® INTERFOLDED FOIL SHEETS	
INDEX BY ITEM NUMBER	21 - 22
RIM STYLES	23
ORDERING INFORMATION	23

FOOD SERVICE ROLL FOIL

HANDI-FOIL®

Eco FRIENDLY BOXES

12" Width

15" Width

18" Width

24" Width



51205 11205 51208



11505 51508



51805 11805 51808 11808 51809



52408 12408

	ITEM#	SIZE	STYLE	CASES PER PALLET	WEIGHT PER CASE (LBS.)	CUBE PER CASE	ITEM UPC 7 49384	
	12" Width							
	51205	12" x 500'	STANDARD	385	4.7	0.10	51205-0	
	11205	12" x 1000'	STANDARD	279	8.75	0.13	11205-2	
	51208	12" x 500'	HEAVY DUTY	350	6.8	0.10	51208-1	
	15" Width							
	11505	15" x 1000'	STANDARD	180	11.2	0.18	11505-3	
	51508	15" x 500'	HEAVY DUTY	180	8.0	0.18	51508-3	
	18" Width							
	51805	18" x 500'	STANDARD	297	6.7	0.14	51805-2	
	11805	18" x 1000'	STANDARD	198	13.4	0.18	11805-4	
	51808	18" x 500'	HEAVY DUTY	234	9.5	0.14	51808-3	
	11808	18" x 1000'	HEAVY DUTY	126	18.5	0.25	11808-5	
	51809	18" x 500'	EXTRA HEAVY DUTY	180	11.4	0.23	51809-0	
	24" Width							
52408	24" x 500'	HEAVY DUTY	70	15.5	0.41	52408-4		
12408	24" x 1000'	HEAVY DUTY	50	25.1	0.41	12408-6		

MEDALLION®

Eco FRIENDLY BOXES

12" Width

18" Width



51207 11203



51803 51807 11803 11807

	ITEM #	SIZE	STYLE	CASES PER PALLET	WEIGHT PER CASE (LBS.)	CUBE PER CASE	ITEM UPC 7 49384	
	12" Width							
	51207	12" x 500'	HEAVY DUTY	385	5.8	0.10	51207-4	
	11203	12" x 1000'	STANDARD	315	7.5	0.10	11203-8	
	18" Width							
	51803	18" x 500'	STANDARD	297	5.5	0.14	51803-8	
	51807	18" x 500'	HEAVY DUTY	297	8.6	0.14	51807-6	
	11803	18" x 1000'	STANDARD	234	11.0	0.14	11803-0	
	11807	18" x 1000'	HEAVY DUTY	144	16.5	0.25	11807-8	

INTERFOLDED FOIL SHEETS

HANDI-FOIL® INTERFOLDED FOIL SHEETS

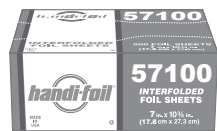

57100

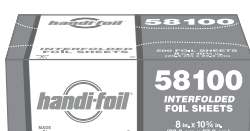

58100

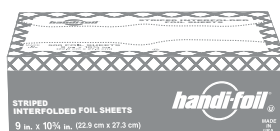

59100RED, 59100BLUE,
59100GREEN

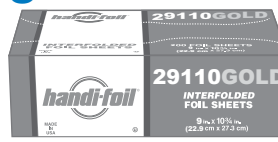

29110 (GOLD)

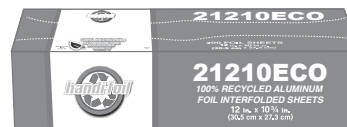

21210ECO

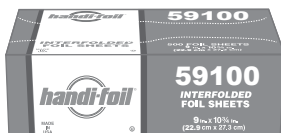

59100

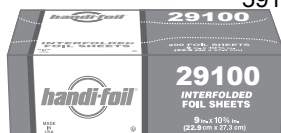

29100

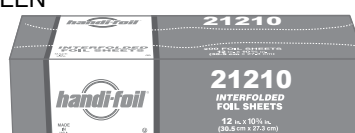

21210

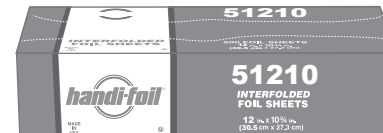

51210, 51210GOLD



ITEM#	SIZE	SHEETS PER CARTON	CARTONS PER CASE	WEIGHT PER CASE (LBS.)	CUBE PER CASE	ITEM UPC
57100	7" x 10 3/4"	500	6	12.4	0.58	57100-2
58100	8" x 10 3/4"	500	6	14.7	0.59	58100-1
29100	9" x 10 3/4"	200	12	14.0	0.84	29100-9
29110	9" x 10 3/4"	200	12	14.0	0.84	29110-8
59100	9" x 10 3/4"	500	6	16.5	0.66	59100-0
59100RED	9" x 10 3/4"	500	6	16.5	0.66	-
59100BLUE	9" x 10 3/4"	500	6	16.5	0.66	-
59100GREEN	9" x 10 3/4"	500	6	16.5	0.66	-
21210	12" x 10 3/4"	200	12	22.0	1.10	21210-3
21210ECO	12" x 10 3/4"	200	12	22.0	1.10	98654-7
51210	12" x 10 3/4"	500	6	25.9	0.89	51210-4
51210GOLD	12" x 10 3/4"	500	6	25.9	0.89	51012-4

MEDALLION® INTERFOLDED FOIL SHEETS



21215

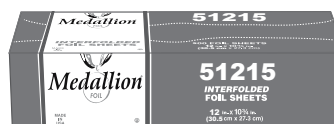

51215



ITEM #	SIZE	SHEETS PER CARTON	CARTONS PER CASE	WEIGHT PER CASE (LBS.)	CUBE PER CASE	ITEM UPC
21215	12" x 10 3/4"	200	12	18.5	1.10	21215-8
51215	12" x 10 3/4"	500	6	21.8	0.89	51215-9

FOOD SERVICE FILM

HANDI-FILM®



21205



21205-S



21805



21805-S



22405

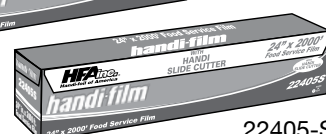

22405-S

ITEM #	SIZE	STYLE	CASES PER PALLET	WEIGHT PER CASE (LBS.)	CUBE PER CASE	ITEM UPC
21205	12" X 2000'	STANDARD	168	5.8 lbs.	0.27	98866-4
21205-S	12" X 2000'	SLIDE CUTTER	168	5.8 lbs.	0.27	98863-3
21805	18" X 2000'	STANDARD	112	8.5 lbs.	0.39	98873-2
21805-S	18" X 2000'	SLIDE CUTTER	112	8.5 lbs.	0.39	98862-6
22405	24" X 2000'	STANDARD	56	11.1 lbs.	0.51	98865-7
22405-S	24" X 2000'	SLIDE CUTTER	56	11.1 lbs.	0.51	98861-9



6051S-500

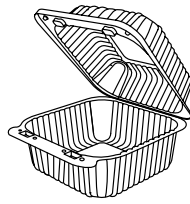

6051D-500

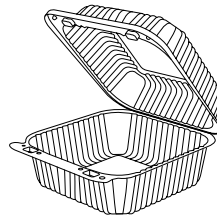

6061D-500

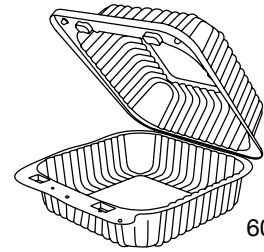

6091S-250

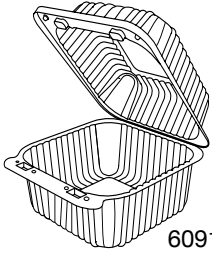

6091D-250

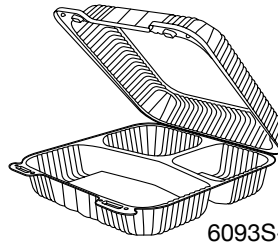

6093S-250

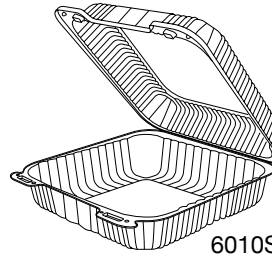

6010S-200

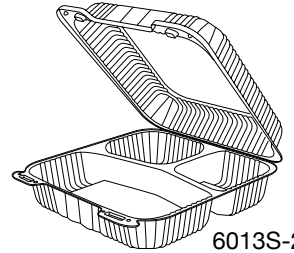

6013S-200

HANDI-LOCK® - CLEAR PLASTIC HINGED CONTAINERS

ITEM #	DESCRIPTION	OUTSIDE DIMENSIONS	CAPACITY (FL OZ) OF CONTAINER BASE	PACKING BAG/CASE	CASE CUBE (CU.FT.)	CASE WEIGHT (LB.)
6051S-500	5" Square / Shallow	5 1/4" x 5 5/8" x 2 3/4"	12	125/500	2.71	16.10
6051D-500	5" Square / Deep	5 1/4" x 5 5/8" x 3 1/4"	16	125/500	2.71	16.10
6061D-500	6" Square / Deep	6 1/8" x 6 1/2" x 3 1/4"	26	125/500	3.58	21.00
6091S-250	9" Shallow	8 7/8" x 8 x 3"	46	125/250	2.69	17.95
6091D-250	9" Deep	8 7/8" x 8" x 3 7/16"	56	125/250	2.69	17.95
6093S-250	9" x 9" Shallow / Three Compartment	8 7/8" x 8" x 3"	8/8/24	125/250	2.69	17.95
6010S-200	10" Shallow	9" x 8 5/8" x 3"	60	100/200	2.50	16.95
6013S-200	10" Shallow / Three Compartment	9" x 8 5/8" x 3"	14/14/30	100/200	2.50	16.95

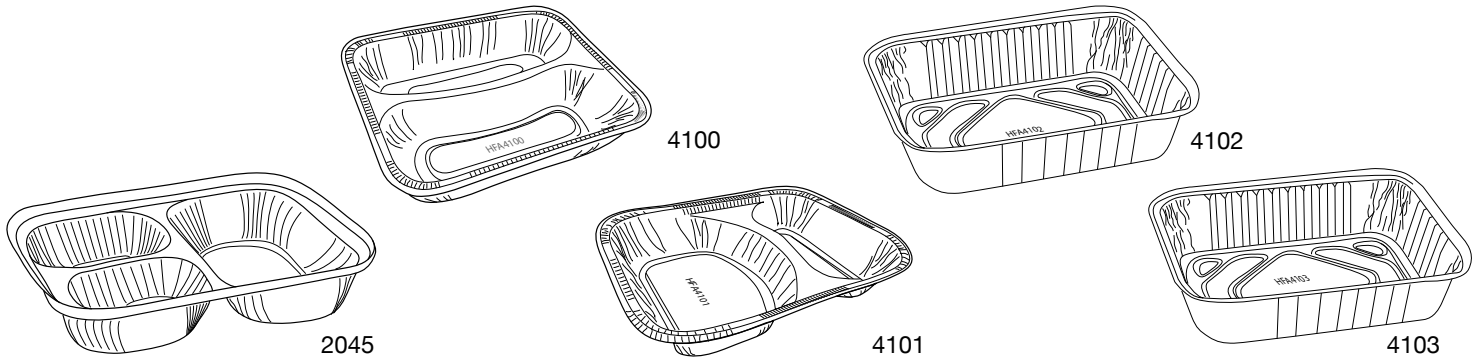

SENIOR & SCHOOL FEEDING

ITEM #	DESCRIPTION	CAPACITY FL OZ.	RIM STYLE	DIMENSIONS (in Inches)				CASE		
				TOP OUT	TOP IN	BOTTOM	VERTICAL DEPTH	LBS.	CUBE	PACK
CONTAINERS										
2045-35-500	Oblong 3-Compartment Tray	24.0	IVCF	8 1/2 x 6 3/8	8 x 5 7/8	7 1/4 x 5 1/8	1 15/32	21.00	4.28	500
4100-30-1000	Hot Dog School Tray	7.9/5.0	FC	6 1/2 x 5	6 x 4 1/2	5 x 3 1/2	1 1/2	19.00	2.50	1000
4101-30-1000	Hamburger School Tray	8.2/4.2	FC	6 1/2 x 5	6 x 4 1/2	5 x 3 1/2	1 1/4	19.50	2.50	1000
4102-30-1000	1 lb. Shallow Oblong	14.0	FC	6 1/2 x 5	6 x 4 1/2	5 x 3 1/2	1 7/16	19.00	2.50	1000
4103-30-1000	1 lb. Deep Oblong	17.8	FC	6 1/2 x 5	6 x 4 1/2	5 x 3 1/2	1 1/2	21.50	2.50	1000
COMBO PACKS										
2045-35-250W	Oblong 3-Compartment Tray w/Lid	24.0	IVCF	8 1/2 x 6 3/8	8 x 5 7/8	7 1/4 x 5 1/8	1 15/32	17.00	1.79	250

STEAM TABLES

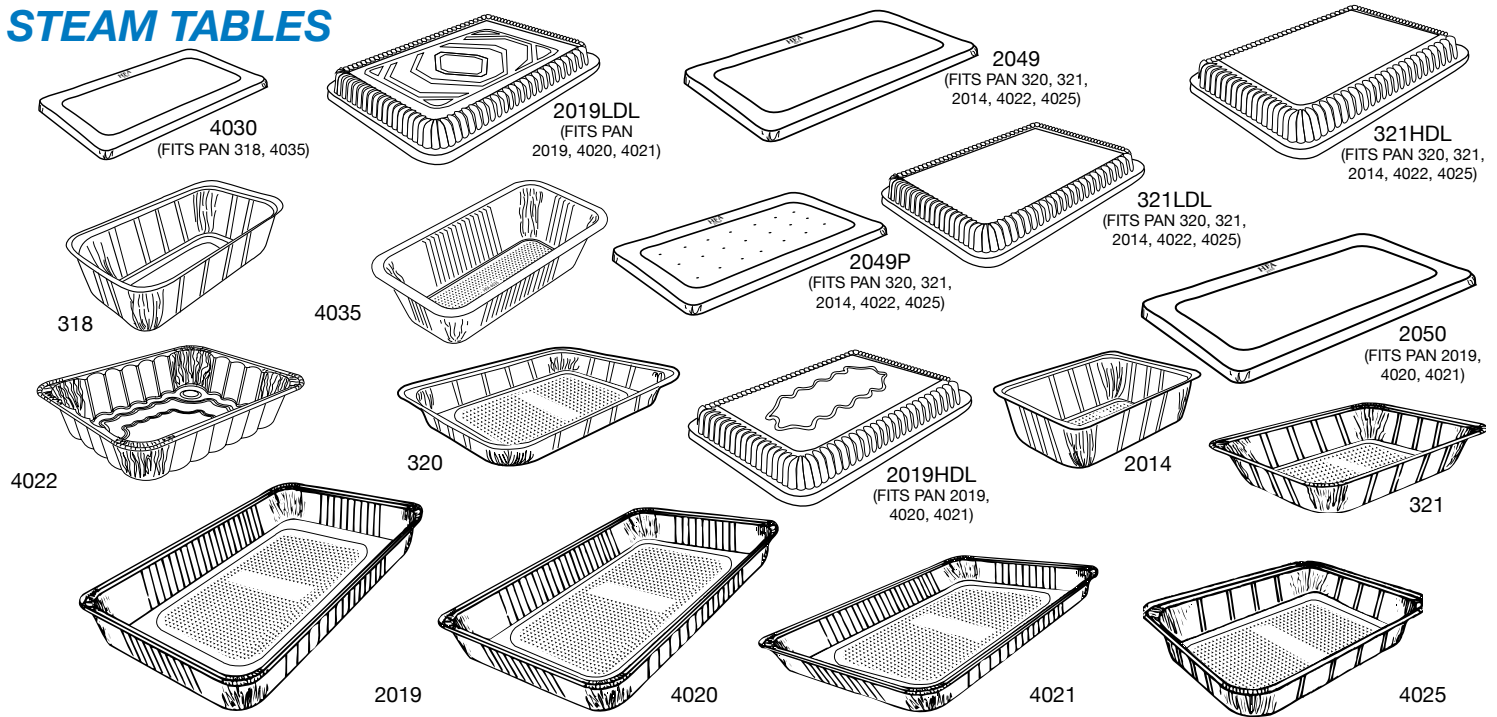

STEAM TABLES											
ITEM #	DESCRIPTION	CAPACITY FL Oz.	RIM STYLE	DIMENSIONS (in Inches)				CASE			
				TOP OUT	TOP IN	BOTTOM	VERTICAL DEPTH	LBS.	CUBE	PACK	
CONTAINERS											
318-40-200	1/3 Size Steam Table - Deep	96.0	FC	12 5/8 x 6 1/2	11 3/4 x 5 5/8	10 3/8 x 4 1/4	3 1/16	16.50	2.05	200	
4035-40-200	Tru-Fit™ 1/3 Size Steam Table - Deep	86.0	FC	12 5/8 x 6 1/2	11 1/2 x 5 1/2	9 15/16 x 3 7/8	2 13/16	14.75	1.88	200	
320-35-100	1/2 Size Steam Table - Shallow	84.0	FC	12 3/4 x 10 3/8	11 3/4 x 9 3/8	10 13/16 x 8 7/16	1 11/16	8.55	1.70	100	
320-40-100	1/2 Size Steam Table - Shallow	84.0	FC	12 3/4 x 10 3/8	11 3/4 x 9 3/8	10 13/16 x 8 7/16	1 11/16	9.77	1.70	100	
4025-40-100	1/2 Size Steam Table - Medium	107.0	FC	12 3/4 x 10 3/8	11 3/4 x 9 3/8	10 1/2 x 8 1/8	2 3/16	10.30	1.76	100	
321-00-100	1/2 Size Steam Table - Deep	128.0	FC	12 3/4 x 10 3/8	11 3/4 x 9 3/8	10 1/4 x 7 7/8	2 9/16	8.06	1.80	100	
321-35-100	1/2 Size Steam Table - Deep	128.0	FC	12 3/4 x 10 3/8	11 3/4 x 9 3/8	10 1/4 x 7 7/8	2 9/16	9.00	1.80	100	
321-40-100	1/2 Size Steam Table - Deep	128.0	FC	12 3/4 x 10 3/8	11 3/4 x 9 3/8	10 1/4 x 7 7/8	2 9/16	10.00	1.80	100	
321-40-100ECO	1/2 Size Steam Table - Deep 100% Recycled Aluminum	128.0	FC	12 3/4 x 10 3/8	11 3/4 x 9 3/8	10 1/4 x 7 7/8	2 9/16	10.00	1.80	100	
321-45-100	1/2 Size Steam Table - Deep	128.0	FC	12 3/4 x 10 3/8	11 3/4 x 9 3/8	10 1/4 x 7 7/8	2 9/16	11.00	2.00	100	
4022-00-100	1/2 size Countoured Steam Table	120.0	FC	12 3/4 x 10 3/8	11 3/4 x 9 3/8	10 1/4 x 7 7/8	2 15/32	10.00	1.80	100	
2014-50-100	1/2 Size Steam Table - Extra Deep	195.0	FC	12 11/16 x 10 5/16	11 3/4 x 9 3/8	9 1/2 x 7 1/8	4 3/16	16.00	2.24	100	
4021-70-50	Full Size Steam Table - Shallow	176.0	FC	20 3/4 x 12 3/4	19 5/8 x 11 3/4	18 5/8 x 10 3/4	1 5/8	13.40	1.84	50	
4020-70-50	Full Size Steam Table - Medium	232.0	FC	20 3/4 x 12 3/4	19 5/8 x 11 5/8	17 5/8 x 9 5/8	2 3/16	14.50	2.07	50	
2019-00-50	Full Size Steam Table - Deep	343.0	FC	20 3/4 x 12 13/16	19 9/16 x 11 5/8	17 3/4 x 9 13/16	3 3/16	14.50	2.09	50	
2019-70-50	Full Size Steam Table - Deep	343.0	FC	20 3/4 x 12 13/16	19 9/16 x 11 5/8	17 3/4 x 9 13/16	3 3/16	15.50	2.09	50	
2019-70-50ECO	Full Size Steam Table - Deep 100% Recycled Aluminum	343.0	FC	20 3/4 x 12 13/16	19 9/16 x 11 5/8	17 3/4 x 9 13/16	3 3/16	15.50	2.09	50	
LIDS											
321LDL-100	Low Dome Lid for 320, 321, 2014, 4022, 4025	—	—	13 3/16 x 10 3/4	—	—	1 5/8	6.50	1.15	100	
321HDL-100	High Dome Lid for 320, 321, 2014, 4022, 4025	—	—	13 1/8 x 10 3/4	—	—	2 1/2	7.00	1.34	100	
4030-25-200	Foil Lid for 318, 4035	—	IVCF	12 11/16 x 6 9/16	—	—	15/32	6.00	1.06	200	
2049-00-100	Foil Lid for 320, 321, 2014, 4022, 4025	—	IVCF	12 13/16 x 10 7/16	—	—	5/8	5.50	0.74	100	
2049-30-100	Foil Lid for 320, 321, 2014, 4022, 4025	—	IVCF	12 13/16 x 10 7/16	—	—	5/8	5.85	0.74	100	
2049-30-100P	Vented Foil Lid for 320, 321, 2014, 4022, 4025	—	IVCF	12 13/16 x 10 7/16	—	—	5/8	5.85	0.74	100	
2050-00-50	Foil Lid for 2019, 4020, 4021	—	IVCF	20 13/16 x 12 7/8	—	—	5/8	7.50	1.00	50	
2050-45-50	Foil Lid for 2019, 4020, 4021	—	IVCF	20 13/16 x 12 7/8	—	—	5/8	8.10	1.00	50	
2019LDL-50	Low Dome Lid for 2019, 4020, 4021	—	—	21 3/16 x 13 3/16	—	—	1 5/8	11.90	1.86	50	
2019HDL-50	High Dome Lid for 2019, 4020, 4021	—	—	21 3/16 x 13 3/16	—	—	3 3/16	12.00	2.53	50	
COMBO PACKS											
3212049-100P	1/2 Size Steam Table - Deep w/Vented Lid	128.0	FC	12 3/4 x 10 3/8	11 3/4 x 9 3/8	10 1/4 x 7 7/8	2 9/16	8.06	1.80	100	

GOURMET-TO-GO®

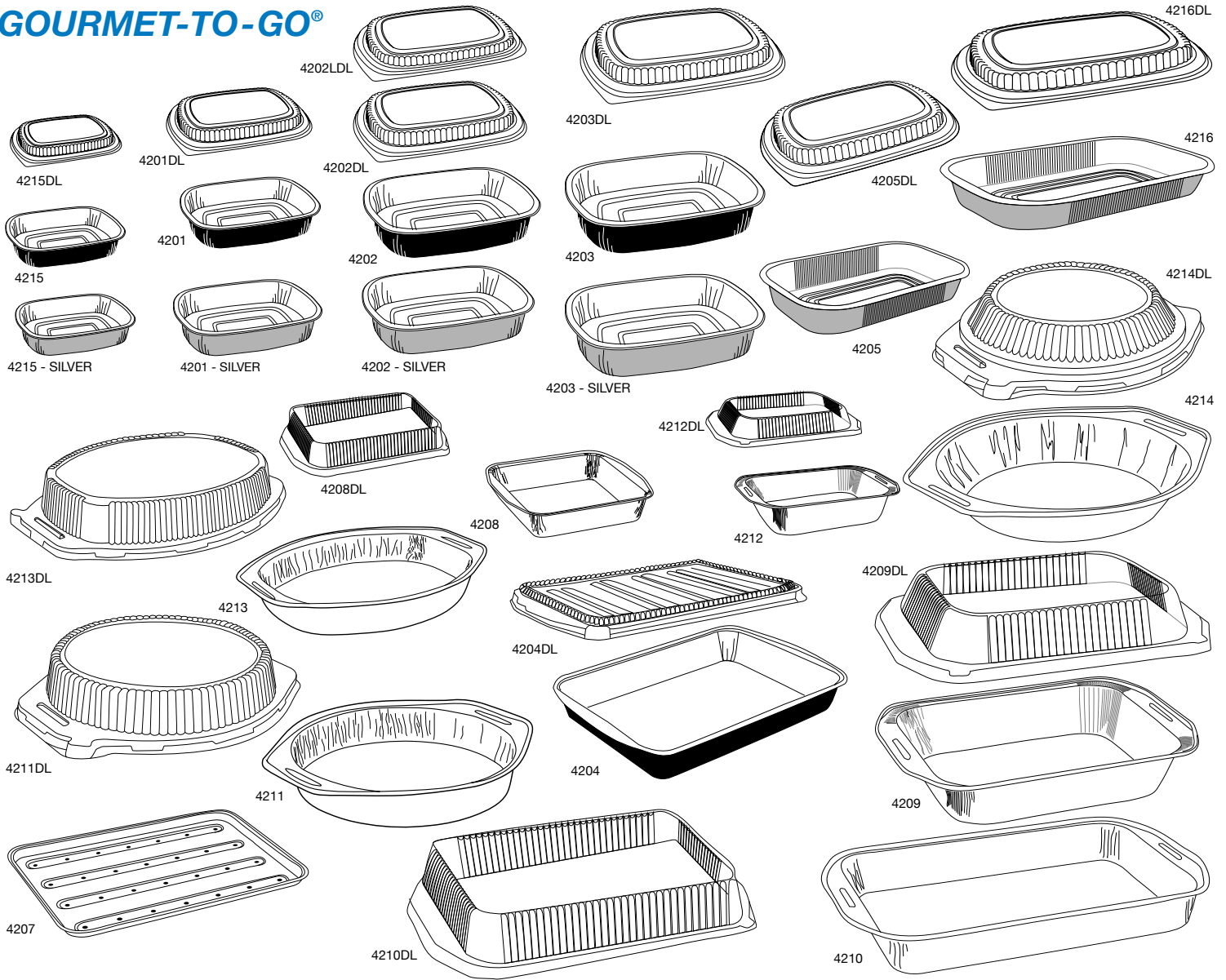

CATERING

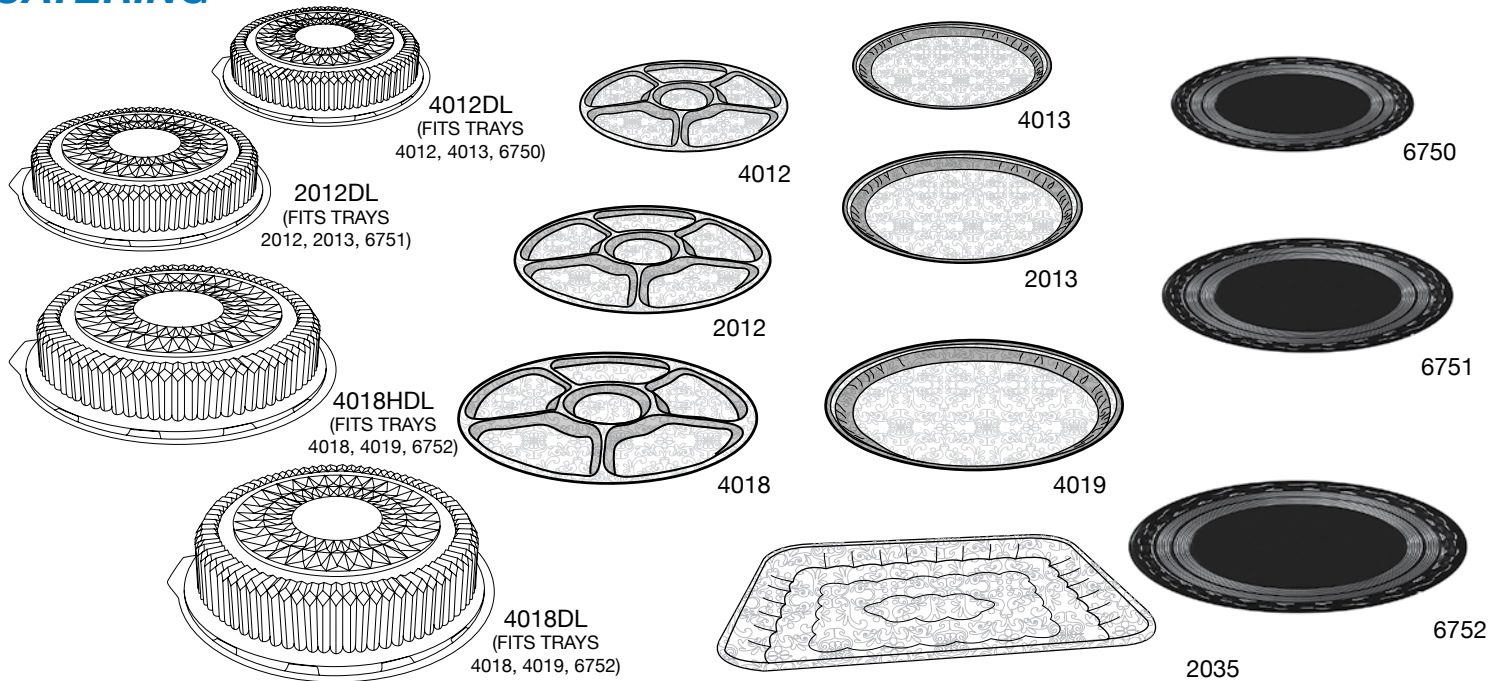

GOURMET-TO-GO®

ITEM #	DESCRIPTION	CAPACITY FL OZ.	RIM STYLE	DIMENSIONS (in Inches)				CASE		
				TOP OUT	TOP IN	BOTTOM	VERTICAL DEPTH	LBS.	CUBE	PACK
CONTAINERS										
4201-55-300	Small entrée - Black & Gold	22.0	FC	8 3/16 x 6 1/8	7 1/2 x 5 1/2	7 3/16 x 5 3/16	1 1/4	13.3	1.17	300
4202-70-150	Medium entrée - Black & Gold	52.0	FC	9 3/4 x 7 3/4	8 15/16 x 6 15/16	8 1/2 x 6 1/2	1 3/4	12.3	1.18	150
4203-70-150	Large entrée - Black & Gold	72.0	FC	11 1/4 x 8 7/8	10 7/16 x 8	10 x 7 1/2	1 3/4	15.6	1.68	150
4201-55-300C	Small entrée - Silver	22.0	FC	8 3/16 x 6 1/8	7 1/2 x 5 1/2	7 3/16 x 5 3/16	1 1/4	13.3	1.17	300
4202-70-150C	Medium entrée - Silver	52.0	FC	9 3/4 x 7 3/4	8 15/16 x 6 15/16	8 1/2 x 6 1/2	1 3/4	12.3	1.18	150
4203-70-150C	Large entrée - Silver	72.0	FC	11 1/4 x 8 7/8	10 7/16 x 8	10 x 7 1/2	1 3/4	15.6	1.68	150
4205-65-300	Smoothwall entrée - Silver	76.0	FC	12 1/2 x 7 7/16	11 5/8 x 6 5/8	11 x 6	1 7/8	31.90	3.20	300
4207-80-50	Grill Pan - Silver	-	FC	13 1/4 x 9 3/8	12 9/16 x 8 13/16	12 7/16 x 8 5/8	5/8	6.60	0.58	50
4216-65-300	Large entrée - Silver	94.0	FC	15 x 7 7/16	14 1/4 x 6 5/8	13 1/2 x 6	1 7/8	36.40	3.90	300
LIDS										
4201DL-300	Dome Lid for 4201	-	-	8 1/4 x 6 3/16	-	-	1 1/4	12.45	2.99	300
4202DL-150	Dome Lid for 4202	-	-	9 13/16 x 7 13/16	-	-	1 3/4	9.75	1.31	150
4202LDL-150	Low Dome Lid for 4202	-	-	9 13/16 x 7 13/16	-	-	5/8	10.60	1.31	150
4203DL-150	Dome Lid for 4203	-	-	11 5/16 x 8 15/16	-	-	1 3/4	12.00	1.49	150
4205DL-300	Dome Lid for 4205	-	-	12 3/16 x 7 1/2	-	-	1 7/8	27.00	2.81	300
4216DL-300	Dome Lid for 4216	-	-	15 1/16 x 7 1/2	-	-	1 7/8	32.00	2.93	300
COMBO PACKS										
4201-55-100WDL	Small entrée w/Dome Lid - Black & Gold	22.0	FC	8 3/16 x 6 1/8	7 1/2 x 5 1/2	7 3/16 x 5 3/16	1 1/4	9.05	1.26	100
4202-70-50WDL	Medium entrée w/Dome Lid - Black & Gold	52.0	FC	9 3/4 x 7 3/4	8 15/16 x 6 15/16	8 1/2 x 6 1/2	1 3/4	8.00	1.16	50
4202-70-50WDL	Medium entrée w/Low Dome Lid - Black & Gold	52.0	FC	9 3/4 x 7 3/4	8 15/16 x 6 15/16	8 1/2 x 6 1/2	1 3/4	7.85	1.16	50
4203-70-50WDL	Large entrée w/Dome Lid - Black & Gold	72.0	FC	11 1/4 x 8 7/8	10 7/16 x 8	10 x 7 1/2	1 3/4	9.75	1.49	50
4204-80-25WDL	Rect Entrée w/Dome Lid - Black & Gold	116.0	FC	14 1/2 x 9 5/8	12 3/4 x 8 5/16	11 7/8 x 8 1/8	1 7/8	7.60	1.47	25
4215-55-100WDL	16 oz. Side Dish w/Dome Lid - Black & Gold	16.0	FC	6 3/8 x 4 21/32	5 27/32 x 4 3/16	5 43/64 x 3 61/64	1 1/4	5.25	.64	100
4201-55-100CWDL	Small entrée w/Dome Lid - Silver	22.0	FC	8 3/16 x 6 1/8	7 1/2 x 5 1/2	7 3/16 x 5 3/16	1 1/4	9.05	1.26	100
4202-70-50CWDL	Medium entrée w/Dome Lid - Silver	52.0	FC	9 3/4 x 7 3/4	8 15/16 x 6 15/16	8 1/2 x 6 1/2	1 3/4	8.00	1.16	50
4203-70-50CWDL	Large entrée w/Dome Lid - Silver	72.0	FC	11 1/4 x 8 7/8	10 7/16 x 8	10 x 7 1/2	1 3/4	9.75	1.49	50
4205-65-150WDL	Entrée w/Dome Lid - Silver	76.0	FC	12 1/2 x 7 7/16	11 5/8 x 6 5/8	11 x 6	1 7/8	30.2	3.40	150
4215-55-100CWDL	16 oz. Side Dish w/Dome Lid - Silver	16.0	FC	6 3/8 x 4 21/32	5 27/32 x 4 3/16	5 43/64 x 3 61/64	1 1/4	5.25	.64	100
4216-65-150WDL	Large entrée w/Dome Lid - Silver	94.0	FC	15 x 7 7/16	14 1/4 x 6 5/8	13 1/2 x 6	1 7/8	33.50	3.52	150
4208-80-50WDL	Square Cake w/Dome Lid - White	67.0	FC	9 11/16 x 8 3/4	8 x 8	7 7/8 x 7 7/8	2	9.57	1.27	50
4209-80-50WDL	1/2 Size Steam Table - Deep - White	139.0	FC	14 1/4 x 10 3/8	11 3/4 x 9 3/8	10 1/4 x 7 7/8	2 9/16	17.87	2.12	50
4210-100-25WDL	Rectangular Roaster w/Dome Lid - White	207.0	FC	17 11/16 x 11 3/16	15 1/4 x 10 1/4	14 1/4 x 9 5/16	2 1/4	14.05	2.05	25
4211-80-50WDL	Round Cake w/Dome Lid - White	64.0	FC	12 x 10 3/8	9 9/16 dia.	8 1/2 dia.	1 5/8	11.00	1.67	50
4212-80-50WDL	Loaf Pan w/Dome Lid - White	54.0	FC	11 7/16 x 5 11/16	8 1/2 x 4 9/16	7 3/4 x 3 3/4	2 3/4	10.75	2.05	50
4213-100-25WDL	Oval Roaster w/Dome Lid - White	192.0	FC	17 7/8 x 13 5/16	15 x 12	14 1/8 x 11 1/8	2 5/16	13.00	2.05	25
4214-80-50WDL	Pie Pan w/Dome Lid - White	54.0	FC	12 x 10 3/8	9 9/16 dia.	8 1/2 dia.	1 5/8	11.00	1.67	50

CATERING

ITEM #	DESCRIPTION	CAPACITY FL OZ.	RIM STYLE	DIMENSIONS (in Inches)				CASE		
				TOP OUT	TOP IN	BOTTOM	VERTICAL DEPTH	LBS.	CUBE	PACK
CONTAINERS										
2035-120-25	Embossed Serving Tray	—	FC	15 x 18	14 x 17	11 1/4 x 14 1/4	1 1/8	10.70	1.52	25
4012-70-25	12" Embossed Lazy Susan	—	FC	12	11 1/4	10	9/16	3.08	0.53	25
4013-80-25	12" Embossed Round Serving Tray	—	FC	12	11 1/4	10	9/16	3.50	0.53	25
2012-80-25	16" Embossed Lazy Susan	—	FC	16	15 1/4	14	13/16	5.62	0.81	25
2013-100-25	16" Embossed Round Serving Tray	—	FC	16	15 1/4	14	13/16	6.64	0.81	25
4018-100-25	18" Embossed Lazy Susan	—	FC	18	17 1/4	16	15/16	8.68	1.06	25
4019-120-25	18" Embossed Round Serving Tray	—	FC	18	17 1/4	16	15/16	9.58	1.06	25
6750-00-25	12" Black Plastic Round Serving Tray	—	—	12	10 5/8	10	1	4.70	0.86	25
6751-00-25	16" Black Plastic Round Serving Tray	—	—	16	14 5/8	14	1	7.50	1.30	25
6752-00-25	18" Black Plastic Round Serving Tray	—	—	18	16 5/8	16	1	11.30	1.81	25
LIDS										
4012DL-25	Plastic Dome Lid for 4012, 4013, 6750	—	—	12	—	—	2 1/2	2.94	1.17	25
2012DL-25	Plastic Dome Lid for 2012, 2013, 6751	—	—	16	—	—	2 1/2	5.25	1.99	25
4018DL-25	Plastic Dome Lid for 4018, 4019, 6752	—	—	18	—	—	2 1/2	7.50	2.56	25
4018HDL-25	Plastic High Dome Lid for 4018, 4019, 6752	—	—	18	—	—	3 1/4	9.00	2.56	25

OBLONGS

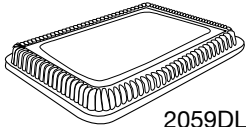

2059DL
(FITS PAN 2059)

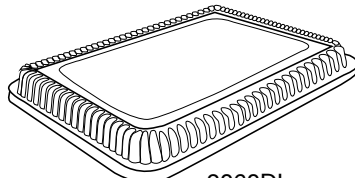

2060DL
(FITS PAN 2060)

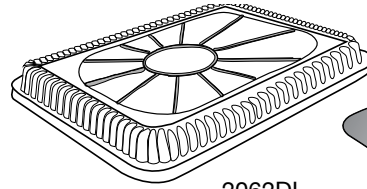

2062DL
(FITS PANS 2061, 2062, 4032)

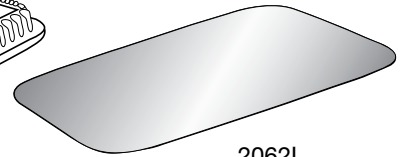

2062L
(FITS PANS 2061, 2062, 4032)

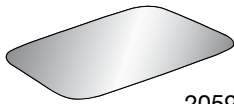

2059L
(FITS PAN 2059)

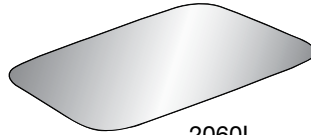

2060L
(FITS PAN 2060)

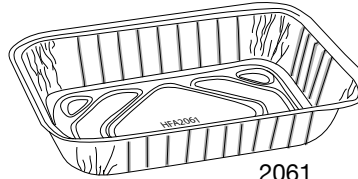

2061

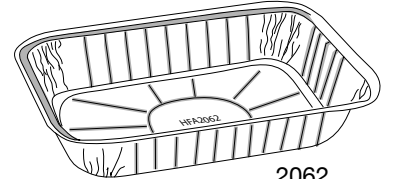

2062

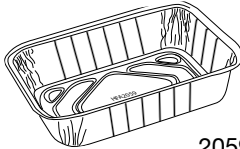

2059

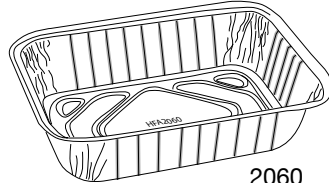

2060

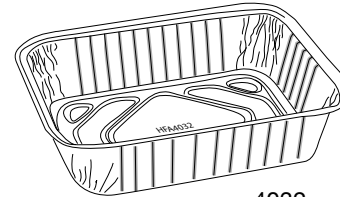

4032

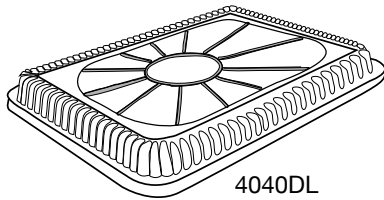

4040DL
(FITS PANS 4040)



363

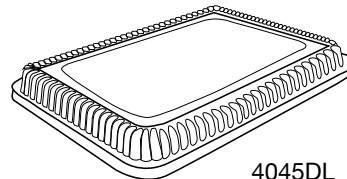

4045DL
(FITS PANS 2045, 4045)

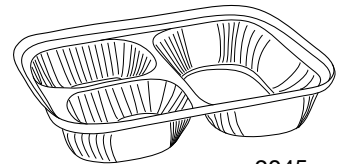

2045

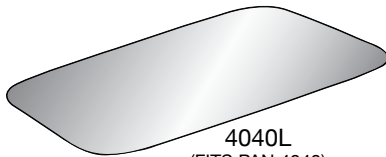

4040L
(FITS PAN 4040)

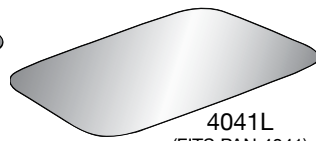

4041L
(FITS PAN 4041)

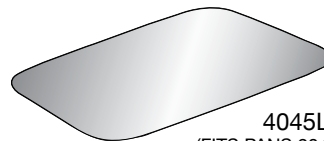

4045L
(FITS PANS 2045, 4045)

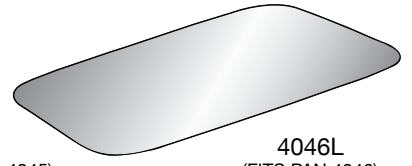

4046L
(FITS PAN 4046)

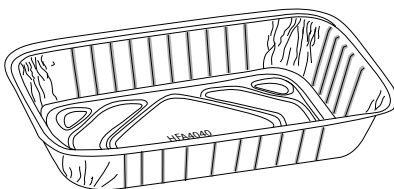

4040

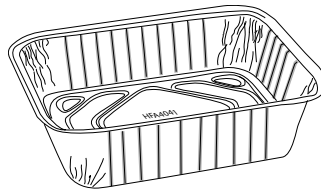

4041

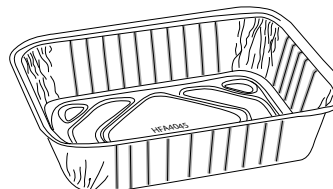

4045

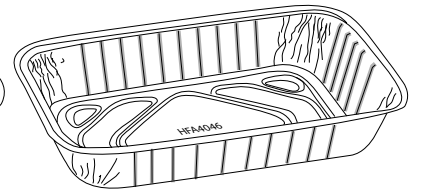

4046

LOAVES

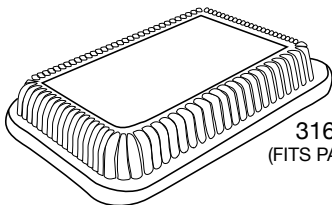

316DL
(FITS PAN 316)

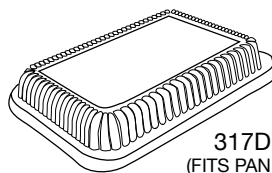

317DL
(FITS PAN 317)

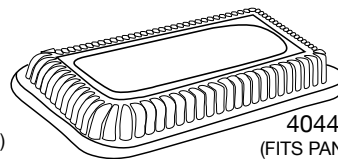

4044DL
(FITS PAN 4044)

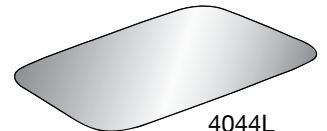

4044L
(FITS PAN 4044)

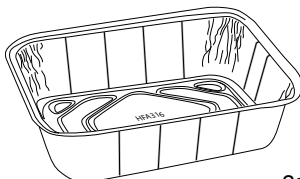

316

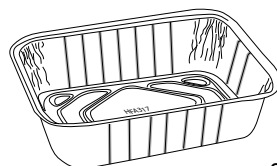

317

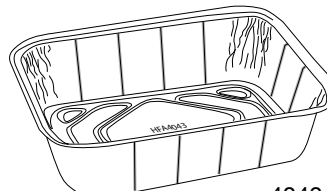

4043

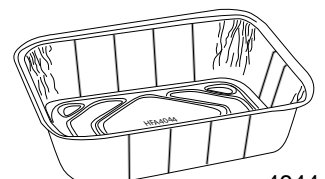

4044

OBLONGS

ITEM #	DESCRIPTION	CAPACITY FL OZ.	RIM STYLE	DIMENSIONS (in Inches)				CASE		
				TOP OUT	TOP IN	BOTTOM	VERTICAL DEPTH	LBS.	CUBE	PACK
CONTAINERS										
2059-30-1000	1 lb. Oblong	15.0	IVCF	5 9/16 x 4 9/16	5 1/8 x 4 1/8	4 3/16 x 3 3/16	1 5/8	18.00	2.39	1000
2060-30-500	1 1/2 lb. Oblong	23.7	IVCF	7 1/16 x 5 1/8	6 9/16 x 4 5/8	5 7/8 x 3 15/16	1 11/16	14.50	2.18	500
2061-30-500	1 1/2 lb. Oblong - Shallow	27.0	IVCF	8 19/32 x 6	7 7/32 x 5 1/2	7 13/32 x 4 3/32	1 1/4	15.80	1.58	500
4032-30-500	2 lb. Carryout	30.0	IVCF	8 11/16 x 6 1/4	7 15/16 x 5 1/2	7 x 4 1/2	1 7/16	15.50	1.82	500
4045-30-500	2 lb. Oblong	33.4	IVCF	8 1/2 x 6 3/8	8 x 5 7/8	7 5/16 x 5 3/16	1 1/2	16.50	2.87	500
2062-30-500	2 1/4 lb. Oblong	36.0	IVCF	8 7/16 x 5 15/16	7 15/16 x 5 7/16	7 x 4 1/2	1 13/16	18.00	1.83	500
363-30-200	2 1/4 lb. Oblong	36.0	FC	8 11/16 x 6 3/16	7 15/16 x 5 7/16	7 x 4 1/2	1 7/8	7.20	1.15	200
4046-40-250	3 lb. Oblong	47.5	IVCF	12 1/4 x 6 1/4	11 3/4 x 5 5/8	11 1/16 x 4 15/16	1 1/2	15.00	2.33	250
4040-45-250	4 lb. Oblong	66.0	IVCF	12 1/8 x 8 1/8	11 1/2 x 7 1/2	11 x 7	1 1/2	21.50	4.14	250
4041-45-250	5 lb. Oblong	80.0	IVCF	9 5/8 x 7 1/8	9 x 6 1/2	8 1/2 x 5 5/8	2 3/4	21.28	4.62	250
LIDS										
2059DL-1000	Plastic Dome Lid for 2059	—	—	5 7/16 x 4 7/16	—	—	3/4	8.38	0.77	1000
2059L-1000	Foil Laminated Board Lid for 2059	—	—	5 1/2 x 4 1/2	—	—	—	11.50	0.30	1000
2060DL-500	Plastic Dome Lid for 2060	—	—	7 x 5	—	—	3/4	6.50	0.55	500
2060L-500	Foil Laminated Board Lid for 2060	—	—	7 x 5	—	—	—	9.00	0.32	500
2062DL-500	Plastic Dome Lid for 2061, 2062, 4032	—	—	8 1/4 x 5 7/8	—	—	3/4	9.10	0.79	500
2062L-500	Foil Laminated Board Lid for 2061, 2062, 4032	—	—	8 7/16 x 5 7/8	—	—	—	11.50	0.33	500
4045DL-500	Plastic Dome Lid for 2045, 4045	—	—	8 3/8 x 6 1/4	—	—	1	9.70	1.08	500
4045L-500	Foil Laminated Board Lid for 2045, 4045	—	—	8 3/8 x 6 1/4	—	—	—	14.50	0.44	500
4040DL-250	Plastic Dome Lid for 4040	—	—	12 1/16 x 8 1/16	—	—	7/8	11.83	1.08	250
4046L-250	Foil Laminated Board Lid for 4046	—	—	12 5/16 x 6 3/16	—	—	—	9.50	0.31	250
4040L-250	Foil Laminated Board Lid for 4040	—	—	12 1/16 x 8 1/16	—	—	—	12.50	0.36	250
4041L-250	Foil Laminated Board Lid for 4041	—	—	9 9/16 x 7	—	—	—	9.00	0.21	250
COMBO PACKS										
2045-35-250W	Oblong 3-Compartment Tray w/Lid	24.0	IVCF	8 1/2 x 6 3/8	8 x 5 7/8	7 1/4 x 5 1/8	1 15/32	17.00	1.79	250
4032-30-250WDL	2 lb. Carryout	30.0	IVCF	8 11/16 x 6 1/4	7 15/16 x 5 1/2	7 x 4 1/2	1 7/16	11.60	1.48	250
2062-30-250W	2 1/4 lb. Oblong w/Lid	36.0	IVCF	8 7/16 x 5 15/16	7 15/16 x 5 7/16	7 x 4 1/2	1 13/16	15.50	1.75	250
2062-30-250WDL	2 1/4 lb. Oblong w/Dome Lid	36.0	IVCF	8 7/16 x 5 15/16	7 15/16 x 5 7/16	7 x 4 1/2	1 13/16	15.50	1.75	250

LOAVES

ITEM #	DESCRIPTION	CAPACITY FL OZ.	RIM STYLE	DIMENSIONS (in Inches)				CASE		
				TOP OUT	TOP IN	BOTTOM	VERTICAL DEPTH	LBS.	CUBE	PACK
CONTAINERS										
316-30-200	2 lb. Loaf	36.0	FC	8 5/8 x 4 1/2	8 x 3 7/8	7 13/32 x 3 5/16	2 19/32	8.00	1.46	200
316-30-500	2 lb. Loaf	36.0	FC	8 5/8 x 4 1/2	8 x 3 7/8	7 13/32 x 3 5/16	2 19/32	20.50	3.37	500
317-30-200	1 lb. Loaf	15.0	FC	6 3/32 x 3 23/32	5 23/32 x 3 5/16	4 29/32 x 2 1/2	2 1/32	4.20	0.53	200
4043-35-500	1 1/2 lb. Loaf	29.0	FC	8 x 4 1/4	7 3/8 x 3 5/8	6 3/4 x 3	2 11/32	18.00	2.41	500
4044-35-500	1 1/2 lb. Loaf	25.0	IVCF	8 x 4 1/8	7 1/2 x 3 5/8	6 9/16 x 2 11/16	2 3/16	17.12	2.41	500
LIDS										
316DL-200	Plastic Dome Lid for 316	—	—	8 7/8 x 4 3/4	—	—	1 1/2	3.50	0.92	200
317DL-200	Plastic Dome Lid for 317	—	—	6 1/8 x 3 3/4	—	—	7/8	2.10	0.64	200
4044DL-500	Plastic Dome Lid for 4044	—	—	7 15/16 x 4 1/16	—	—	9/16	7.75	0.86	500
4044L-500	Foil Laminated Board Lid for 4044	—	—	7 15/16 x 4 1/16	—	—	—	7.94	0.19	500

ROUNDS

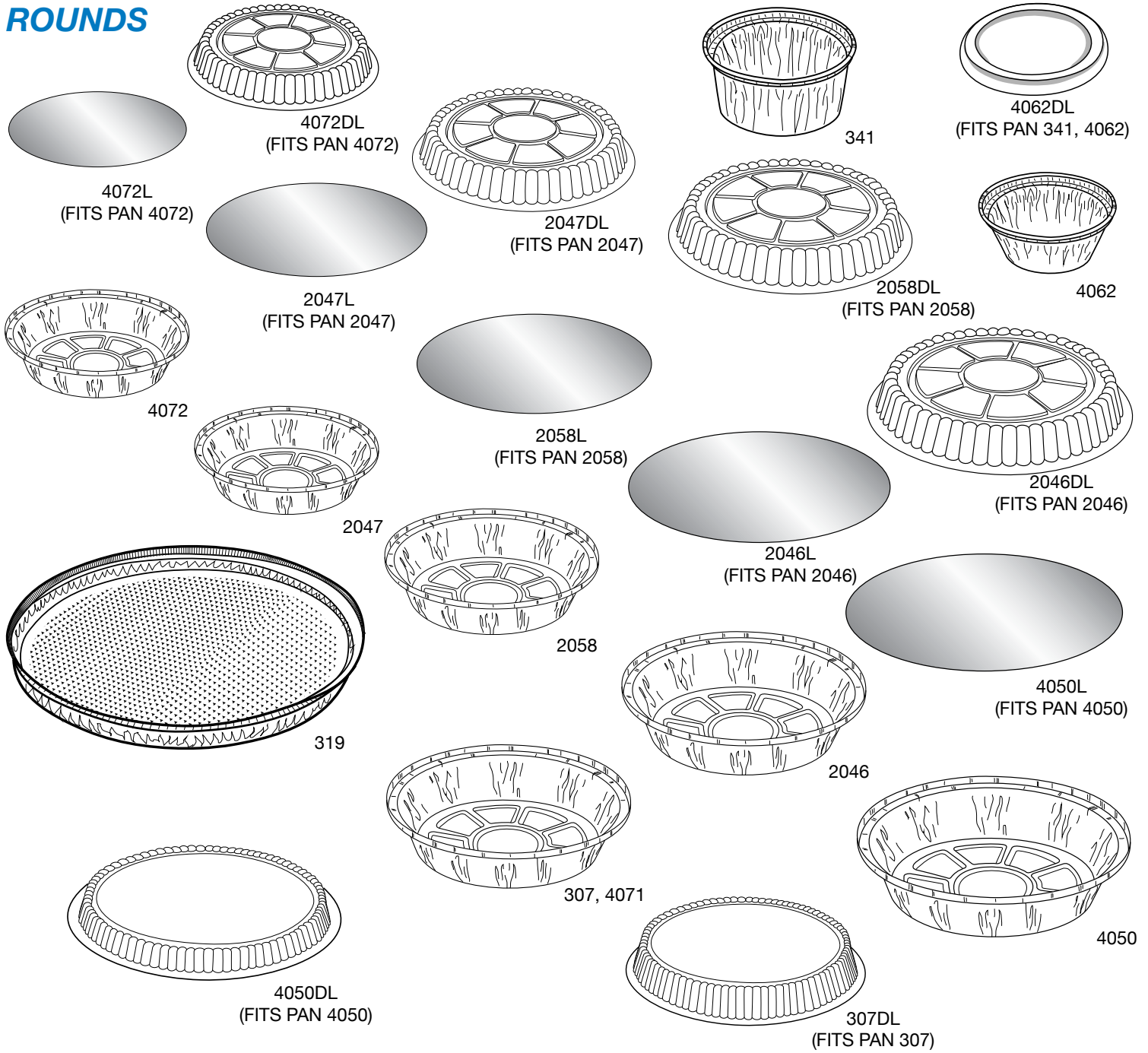

DANISH

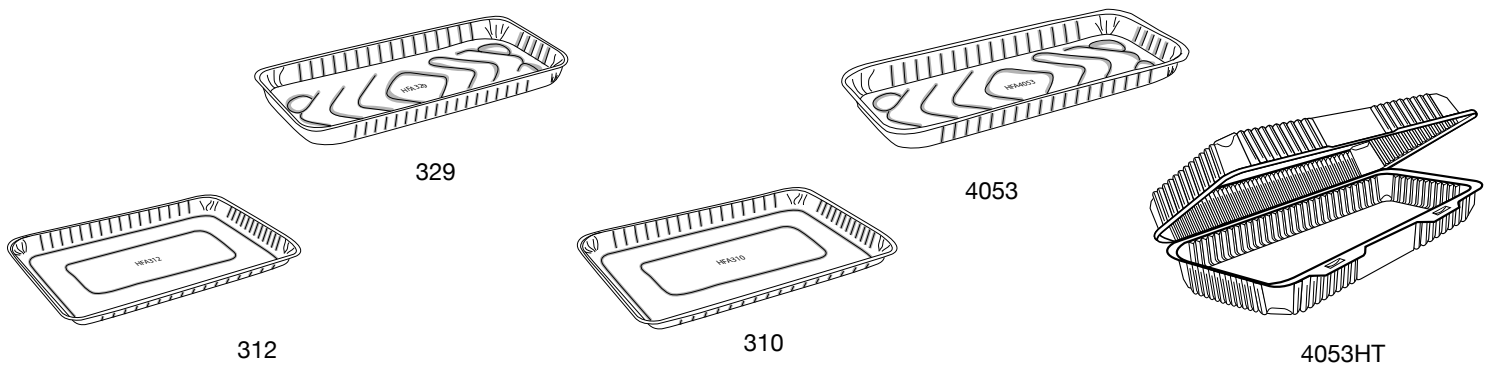

ROUNDS

ITEM #	DESCRIPTION	CAPACITY FL OZ.	RIM STYLE	DIMENSIONS (in Inches)				CASE		
				TOP OUT	TOP IN	BOTTOM	VERTICAL DEPTH	LBS.	CUBE	PACK
CONTAINERS										
4072-25-500	7" Round-Slim	20.0	IVCF	6 13/16	6	5 3/32	1 3/4	8.31	2.01	500
2047-00-500	7" Round	24	VHE	7 1/8	6 9/16	5 9/16	1 15/32	10.07	1.97	500
2047-25-500	7" Round	24.0	VHE	7 1/8	6 9/16	5 9/16	1 15/32	11.00	1.97	500
2047-30-500	7" Round	24.0	VHE	7 1/8	6 9/16	5 9/16	1 15/32	13.00	1.97	500
2058-30-500	8" Round	37.0	VHE	8 5/16	7 13/16	7 1/32	1 9/16	15.50	3.17	500
307-30-200	9" Round	40.0	FC	9	8 1/2	7 7/8	1 7/16	7.00	1.46	200
307-30-500	9" Round	40.0	FC	9	8 1/2	7 7/8	1 7/16	17.50	3.40	500
2046-00-500	9" Round	48.0	VHE	8 15/16	8 3/8	7 25/32	1 21/32	16.00	3.07	500
2046-30-500	9" Round	48.0	VHE	8 15/16	8 3/8	7 25/32	1 21/32	20.00	3.07	500
4071-45-500	9" Round	38.0	FC	8 15/16	8 7/16	7 7/8	1 1/2	25.90	3.32	500
4050-00-250	10" Round	68.3	VHE	10 1/16	9 7/16	8 21/32	2 1/4	12.35	4.19	250
4050-35-250	10" Round	68.3	VHE	10 1/16	9 7/16	8 21/32	2 1/4	15.20	4.19	250
319-30-250	12" Pizza	38.0	FC	13	12 13/32	12	3/8	13.50	3.33	250
4062-30-1000	3 1/2 oz. Cup	3.5	FC	3 1/4	2 13/16	1 7/8	1 13/32	7.50	1.15	1000
341-30-1000	4 oz. Cup	4.0	FC	3 3/8	3 1/8	2 5/8	1 9/16	9.00	2.23	1000
LIDS										
4072DL-500	Plastic Dome Lid for 4072	—	—	6 5/8	—	—	15/16	7.58	0.72	500
4072L-500	Foil Laminated Board Lid for 4072	—	—	6 9/16	—	—	—	9.31	0.27	500
2047DL-500	Plastic Dome Lid for 2047	—	—	6 15/16	—	—	7/8	7.20	0.74	500
2047L-500	Foil Laminated Board Lid for 2047	—	—	7	—	—	—	9.50	0.44	500
2058DL-500	Plastic Dome Lid for 2058	—	—	8 1/4	—	—	7/8	10.00	0.95	500
2058L-500	Foil Laminated Board Lid for 2058	—	—	8 1/4	—	—	—	13.50	0.44	500
307DL-200	Plastic Dome Lid for 307	—	—	8 7/8	—	—	1 1/2	5.25	1.58	200
2046DL-500	Plastic Dome Lid for 2046	—	—	8 7/8	—	—	7/8	12.20	1.10	500
2046L-500	Foil Laminated Board Lid for 2046	—	—	9	—	—	—	16.50	0.49	500
4050DL-250	Plastic Dome Lid for 4050	—	—	10	—	—	3/4	8.50	0.92	250
4050L-250	Foil Laminated Board Lid for 4050	—	—	10	—	—	—	9.50	0.31	250
4062DL-1000	Plastic Dome Lid for 341, 4062	—	—	3 5/16	—	—	9/32	4.50	1.15	1000
COMBO PACKS										
4072-25-200W	7" Round-Slim w/Lid	20.0	IVCF	6 13/16	6 3/32	5 3/32	1 5/8	7.74	1.13	200
4072-25-250WDL	7" Round-Slim w/Dome Lid	20.0	IVCF	6 13/16	6 3/32	5 3/32	1 5/8	7.90	1.31	250
2047-00-200W	7" Round w/Lid	24.0	VHE	7 1/8	6 9/16	5 9/16	1 15/32	8.19	1.04	200
2047-25-200W	7" Round w/Lid	24.0	VHE	7 1/8	6 9/16	5 9/16	1 15/32	8.50	1.04	200
2047-25-250W	7" Round w/Lid	24.0	VHE	7 1/8	6 9/16	5 9/16	1 15/32	10.50	1.16	250
2047-25-250WDL	7" Round w/Dome Lid	24.0	VHE	7 1/8	6 9/16	5 9/16	1 15/32	9.50	1.50	250
2047-30-200W	7" Round w/Lid	24.0	VHE	7 1/8	6 9/16	5 9/16	1 15/32	9.50	1.04	200
2047-30-250W	7" Round w/Lid	24.0	VHE	7 1/8	6 9/16	5 9/16	1 15/32	11.00	1.16	250
2047-30-250WDL	7" Round w/Dome Lid	24.0	VHE	7 1/8	6 9/16	5 9/16	1 15/32	11.00	1.50	250
2058-30-200W	8" Round w/Lid	37.0	VHE	8 5/16	7 13/16	7 1/32	1 9/16	12.00	1.61	200
2058-30-250W	8" Round w/Lid	37.0	VHE	8 5/16	7 13/16	7 1/32	1 9/16	15.00	1.92	250
2058-30-250WDL	8" Round w/Dome Lid	37.0	VHE	8 5/16	7 13/16	7 1/32	1 9/16	13.50	1.92	250
2046-00-200W	9" Round w/Lid	48.0	VHE	8 15/16	8 3/8	7 25/32	1 21/32	13.87	1.80	200
2046-30-200W	9" Round w/Lid	48.0	VHE	8 15/16	8 3/8	7 25/32	1 21/32	15.00	1.80	200
2046-30-250W	9" Round w/Lid	48.0	VHE	8 15/16	8 3/8	7 25/32	1 21/32	18.00	2.06	250
2046-30-250WDL	9" Round w/Dome Lid	48.0	VHE	8 15/16	8 3/8	7 25/32	1 21/32	16.00	2.68	250

DANISH

ITEM #	DESCRIPTION	CAPACITY FL OZ.	RIM STYLE	DIMENSIONS (in Inches)				CASE		
				TOP OUT	TOP IN	BOTTOM	VERTICAL DEPTH	LBS.	CUBE	PACK
CONTAINERS										
312-30-200	Oblong Danish	26.0	FC	8 13/16 x 5 13/16	8 13/32 x 5 13/32	7 15/16 x 4 15/16	1 7/32	6.32	0.92	200
329-30-500	Oblong Danish	18.0	FC	10 1/4 x 5 1/4	9 15/16 x 4 15/16	9 9/16 x 4 1/2	13/16	14.00	2.12	500
310-25-200	Oblong Danish	23.0	FC	11 1/2 x 7 1/4	11 x 6 3/4	10 1/2 x 6 1/4	3/4	7.00	1.73	200
4053-30-250	Oblong Danish	24.5	FC	12 3/8 x 5 3/8	11 7/8 x 4 7/8	11 7/16 x 4 7/16	1	8.50	1.39	250
4053HT-250	Hinged Plastic Tray for 4053	44.0	—	13 1/8 x 6 31/32	—	—	2 3/8	21.50	2.44	250

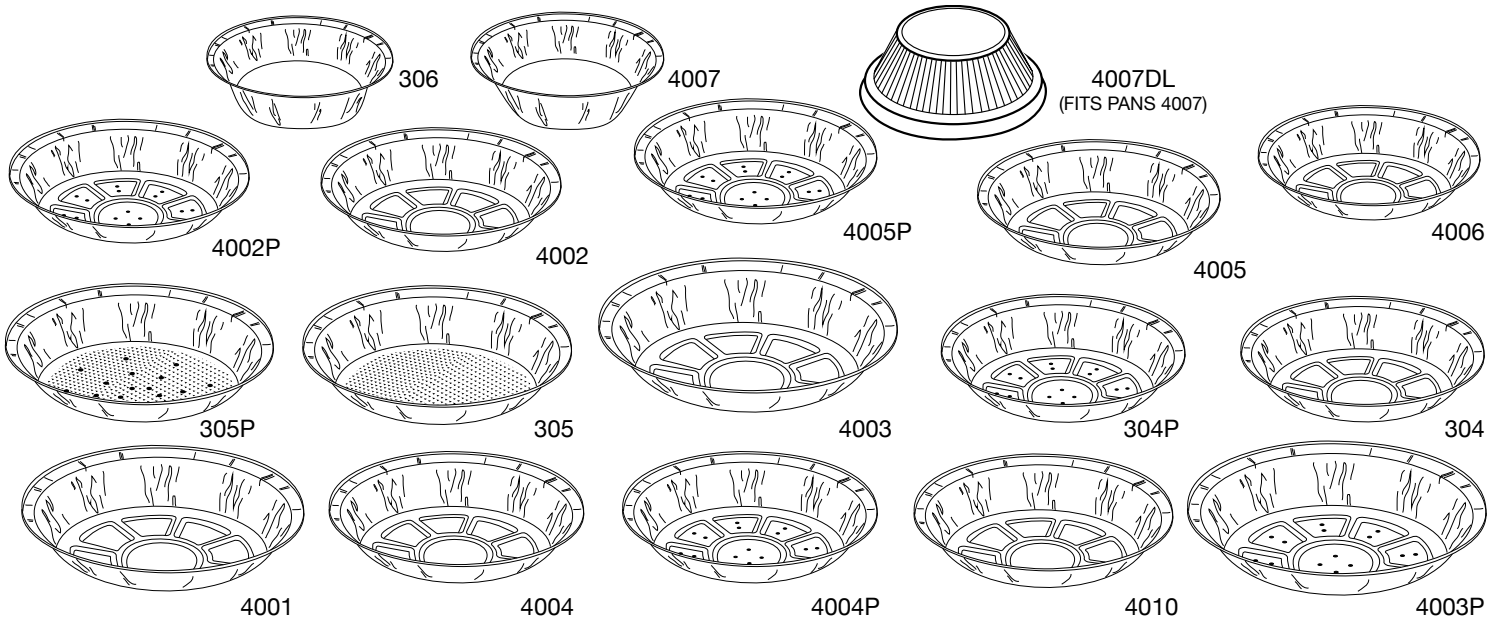

PIES

ITEM #	DESCRIPTION	CAPACITY FL. OZ.	RIM STYLE	DIMENSIONS (in Inches)				CASE			
				TOP OUT	TOP IN	BOTTOM	VERTICAL DEPTH	LBS.	CUBE	PACK	
CONTAINERS											
304-30-200	9" Pie	24.0	FC	9	8	6 3/8	1 1/16	6.10	1.08	200	
304-30-200P	9" Perforated Pie	24.0	FC	9	8	6 3/8	1 1/16	6.10	1.08	200	
304-40-200	9" Pie	24.0	FC	9	8	6 3/8	1 1/16	7.83	1.08	200	
304-40-200P	9" Perforated Pie	24.0	FC	9	8	6 3/8	1 1/16	7.83	1.08	200	
305-35-200	10" Pie	33.4	FC	9 5/8	8 3/4	7	1 7/32	7.80	1.61	200	
305-35-200P	10" Perforated Pie	33.4	FC	9 5/8	8 3/4	7	1 7/32	7.80	1.61	200	
306-25-2000	5" Tart	8.0	FC	5	4 1/4	3 3/8	1 1/4	20.15	2.48	2000	
4001-50-500	11" Extra Deep Pie	46.0	FC	10 9/16	9 11/16	7 19/32	1 13/32	33.00	4.19	500	
4002-30-500	8" Pie	16.0	FC	7 31/32	7 1/16	5 3/4	27/32	12.25	2.82	500	
4002-30-500P	8" Perforated Pie	16.0	FC	7 31/32	7 1/16	5 3/4	27/32	12.25	2.82	500	
4003-50-250	12" Pie	60.0	FC	11 11/16	10 31/32	9	1 1/4	19.65	2.58	250	
4003-50-250P	12" Perforated Pie	60.0	FC	11 11/16	10 31/32	9	1 1/4	19.65	2.58	250	
4004-40-500	9" Extra Deep Pie	32.0	FC	9 1/32	8 5/16	6 5/8	1 1/4	21.25	3.37	500	
4004-40-500P	9" Extra Deep Perforated Pie	32.0	FC	9 1/32	8 5/16	6 5/8	1 1/4	21.25	3.37	500	
4005-35-500	8" Extra Deep Pie	22.0	FC	7 7/8	7 1/16	5 1/2	1 3/16	14.00	2.41	500	
4005-35-500P	8" Extra Deep Perforated Pie	22.0	FC	7 7/8	7 1/16	5 1/2	1 3/16	14.00	2.41	500	
4006-30-1000	6" Pie	9.0	FC	5 15/16	5 3/8	4	1 9/16	14.50	2.37	1000	
4007-30-1000	Pot Pie	12.0	FC	5 23/32	5	3 3/8	1 1/2	15.50	2.42	1000	
4010-45-500	10" Medium Pie	26.0	FC	9 5/8	8 3/4	7 7/16	1	24.95	2.96	500	
LIDS											
4007DL-1000	Plastic Dome Lid for 4007	-	-	6	-	-	1 3/4	15.40	4.97	1000	

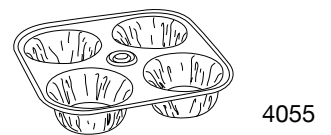
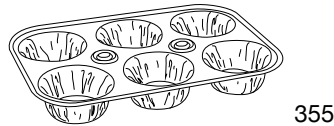
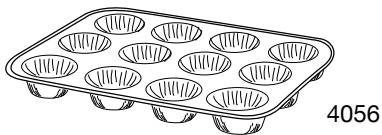

MUFFINS

ITEM #	DESCRIPTION	CAPACITY FL. OZ.	RIM STYLE	DIMENSIONS (in Inches)				CASE		
				TOP OUT	TOP IN	BOTTOM	VERTICAL DEPTH	LBS.	CUBE	PACK
CONTAINERS										
4056-35-250	Mini Muffin - 12 Cavity	12.0	FC	9 3/8 x 7 1/8	1 5/8 Cup Dia	1 1/4 Cup Dia	1 1/16	12.50	2.58	250
355-33-200	Standard Muffin - 6 Cavity	18.6	FC	9 15/16 x 6 11/16	2 3/4 Cup Dia	2 Cup Dia	1 3/8	11.28	2.05	200
4055-30-300	Giant Muffin - 4 Cavity	21.0	FC	8 1/4 x 8 1/4	3 1/2 Cup Dia	2 1/16 Cup Dia	1 13/16	16.00	2.94	300

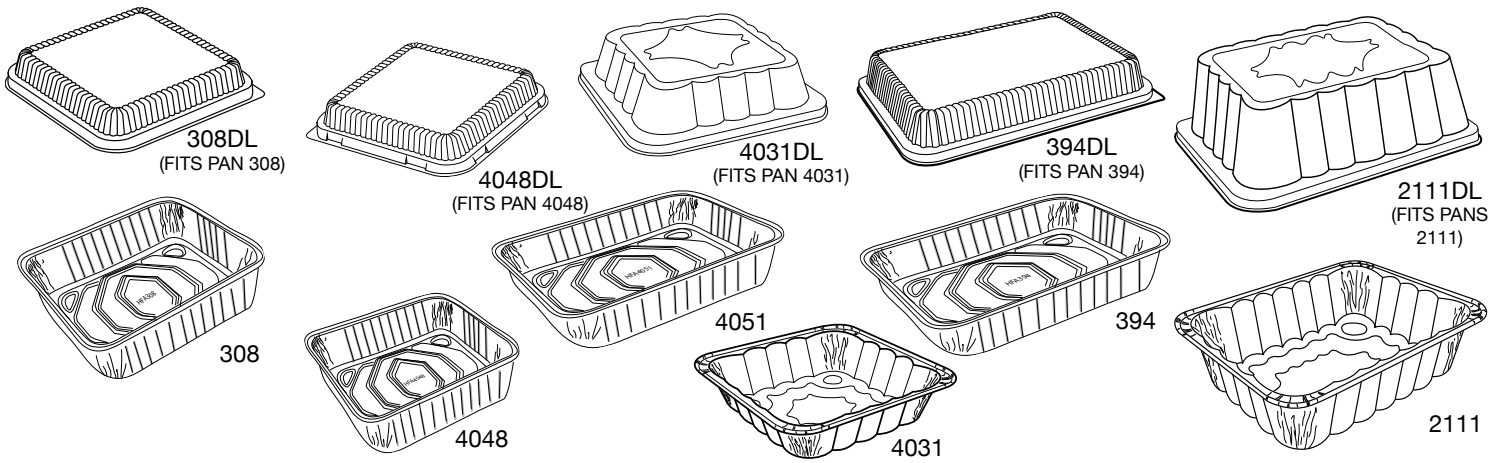

SQUARES / CAKES

ITEM #	DESCRIPTION	CAPACITY FL. OZ.	RIM STYLE	DIMENSIONS (in Inches)				CASE			
				TOP OUT	TOP IN	BOTTOM	VERTICAL DEPTH	LBS.	CUBE	PACK	
CONTAINERS											
308-30-200	9" Square Cake	48.0	FC	8 3/4 x 8 3/4	8 x 8	7 1/2 x 7 1/2	1 17/32	8.50	1.41	200	
308-30-500	9" Square Cake	48.0	FC	8 3/4 x 8 3/4	8 x 8	7 1/2 x 7 1/2	1 17/32	22.00	3.40	500	
394-40-100	Oblong	108.0	FC	13 9/16 x 9 13/16	12 3/4 x 9	11 7/8 x 8 1/8	2	10.10	1.44	100	
4031-35-200	Square Poultry	96.0	FC	10 3/8 x 10 3/8	9 3/8 x 9 3/8	7 3/4 x 7 3/4	2 3/8	17.00	4.19	200	
4048-35-500	8" Square Cake	32.4	FC	7 7/8 x 7 7/8	7 3/8 x 7 3/8	6 7/8 x 6 7/8	1 5/16	21.00	2.82	500	
4051-30-1000	Oblong Cake	45.0	FC	9 3/4 x 7 5/16	9 3/8 x 6 15/16	9 x 6 1/16	1 5/16	39.00	6.19	1000	
2111-50-100	Deep Utility Pan	208.0	FC	13 9/16 x 9 13/16	12 3/4 x 9	11 1/8 x 7 3/8	3 7/8	14.90	2.33	100	
LIDS											
394DL-100	Plastic Dome Lid for 394, 80394	—	—	13 3/8 x 9 15/16	—	—	1 1/2	6.30	1.64	100	
308DL-200	Plastic Dome Lid for 308, 80396	—	—	8 5/8 x 8 5/8	—	—	1 5/8	7.20	1.36	200	
4031DL-200	Plastic Dome Lid for 4031	—	—	10 1/4 x 10 1/4	—	—	2 1/2	12.00	2.64	200	
4048DL-500	Plastic Dome Lid for 4048	—	—	8 1/4 x 8 1/4	—	—	1 1/2	17.00	3.38	500	
2111DL-100	Plastic Dome Lid for 2111	—	—	14 x 10 1/2	—	—	4 1/4	13.00	4.62	100	
COMBO PACKS											
4048-35-100WDL	8" Square Cake w/Dome Lid	32.4	FC	7 7/8 x 7 7/8	7 3/8 x 7 3/8	6 7/8 x 6 7/8	1 5/16	7.50	1.22	100	

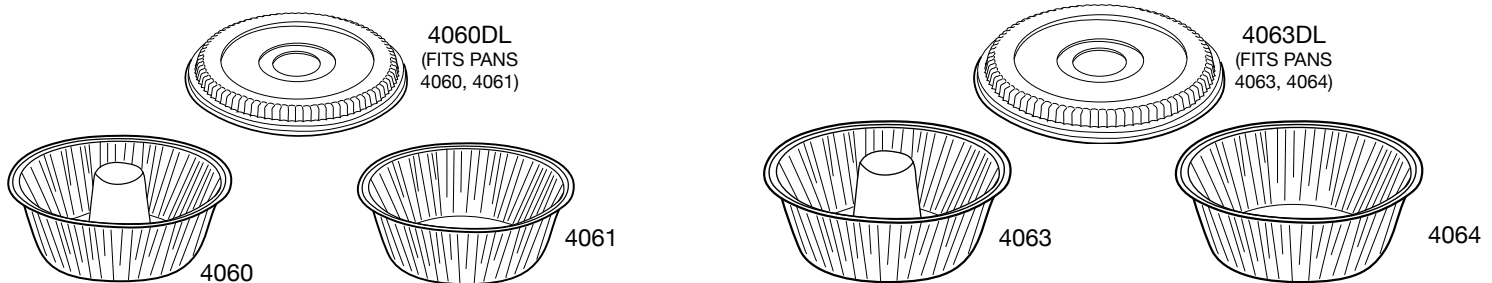

ANGEL FOODS

ITEM #	DESCRIPTION	CAPACITY FL. OZ.	RIM STYLE	DIMENSIONS (in Inches)				CASE			
				TOP OUT	TOP IN	BOTTOM	VERTICAL DEPTH	LBS.	CUBE	PACK	
CONTAINERS											
4060-35-250	8" Angel Food w/Cup	60.0	FC	8 3/4	7 15/16	5 7/8	3 5/32	16.50	3.55	250	
4061-35-250	8" Round Baking - Deep	66.0	FC	8 3/4	7 15/16	5 7/8	3 5/32	14.00	3.55	250	
4063-35-250	10" Angel Food w/Cup	78.0	FC	9 7/8	9 1/4	7 7/16	3 7/8	24.00	4.59	250	
4064-35-250	10" Round Baking - Deep	78.0	FC	9 7/8	9 1/4	7 7/16	3 7/8	22.00	4.19	250	
LIDS											
4060DL-250	Plastic Dome Lid for 4060, 4061	—	—	9 x 9	—	—	1	8.00	1.44	250	
4063DL-250	Plastic Dome Lid for 4063, 4064	—	—	10 1/4	—	—	1	13.00	4.86	250	
COMBO PACKS											
4060-35-100WDL	8" Angel Food w/Dome Lid	60.0	FC	8 3/4	7 15/16	5 7/8	3 5/32	10.77	2.58	100	
4063-35-100WDL	10" Angel Food w/Dome Lid	78.0	FC	9 7/8	9 1/4	7 7/16	3 7/8	14.60	3.55	100	

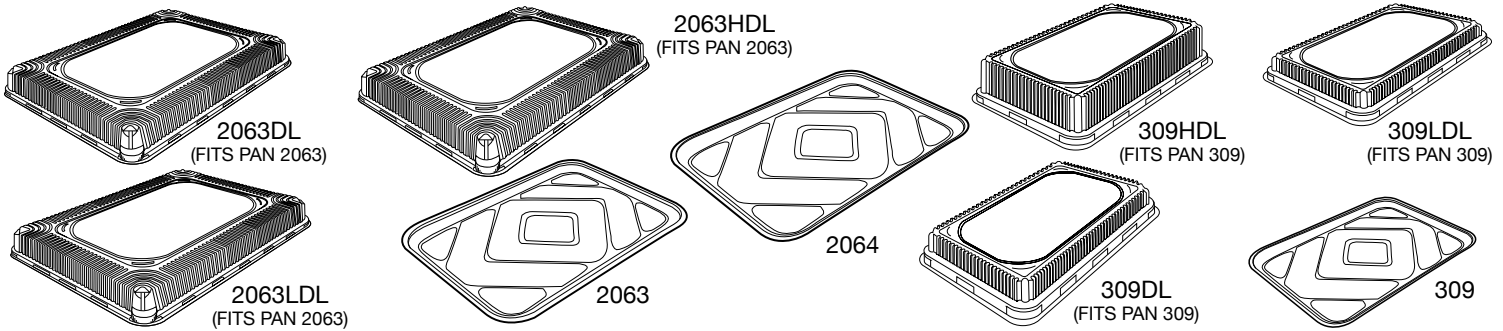

SHEET CAKES

ITEM #	DESCRIPTION	CAPACITY FL. Oz.	RIM STYLE	DIMENSIONS (in Inches)				CASE			
				TOP OUT	TOP IN	BOTTOM	VERTICAL DEPTH	LBS.	CUBE	PACK	
CONTAINERS											
309-35-100	¼ Size Sheet Cake	58.0	FC	12 13/16 x 8 13/16	12 ¼ x 8 ¼	11 9/16 x 7 9/16	1 ¼	6.78	1.27	100	
309-40-100	¼ Size Sheet Cake	58.0	FC	12 13/16 x 8 13/16	12 ¼ x 8 ¼	11 9/16 x 7 9/16	1 ¼	7.60	1.27	100	
309-45-100	¼ Size Sheet Cake	58.0	FC	12 13/16 x 8 13/16	12 ¼ x 8 ¼	11 9/16 x 7 9/16	1 ¼	8.50	1.27	100	
2063-55-100	½ Size Sheet Cake	130.0	FC	17 5/8 x 12 13/16	17 ½ x 12 5/16	16 7/16 x 11 5/8	1 ¼	17.70	2.37	100	
2064-00-25	Full Size Sheet Cake	240.0	FC	25 13/16 x 17 13/16	24 13/16 x 16 13/16	24 ¼ x 16 ¼	1 11/16	13.50	2.26	25	
LIDS											
309DL-100	Plastic Dome Lid for 309	—	—	12 ¾ x 8 ¾	—	—	1 5/8	5.65	0.84	100	
309HDL-100	Plastic High Dome Lid for 309	—	—	12 ¾ x 8 ¾	—	—	2 3/16	9.00	1.65	100	
309LDL-100	Plastic Low Dome Lid for 309	—	—	12 ¾ x 8 ¾	—	—	1 3/16	7.00	1.65	100	
2063DL-100	Plastic Dome Lid for 2063	—	—	18 1/2 x 13 7/32	—	—	1 7/8	16.50	3.62	100	
2063HDL-100	Plastic High Dome Lid for 2063	—	—	18 1/2 x 13 7/32	—	—	2	16.50	3.62	100	
2063LDL-100	Plastic Low Dome Lid for 2063	—	—	18 1/2 x 13 7/32	—	—	1 ¼	20.00	3.62	100	
COMBO PACKS											
309-40-50WDL	¼ Size Sheet Cake w/Dome Lid	58.0	FC	12 13/16 x 8 13/16	12 ¼ x 8 ¼	11 9/16 x 7 9/16	1 ¼	6.80	1.39	50	
309-45-50WDL	¼ Size Sheet Cake w/Dome Lid	58.0	FC	12 13/16 x 8 13/16	12 ¼ x 8 ¼	11 9/16 x 7 9/16	1 ¼	7.65	1.39	50	
309-40-50WHDL	¼ Size Sheet Cake w/High Dome Lid	58.0	FC	12 13/16 x 8 13/16	12 ¼ x 8 ¼	11 9/16 x 7 9/16	1 ¼	7.88	1.39	50	

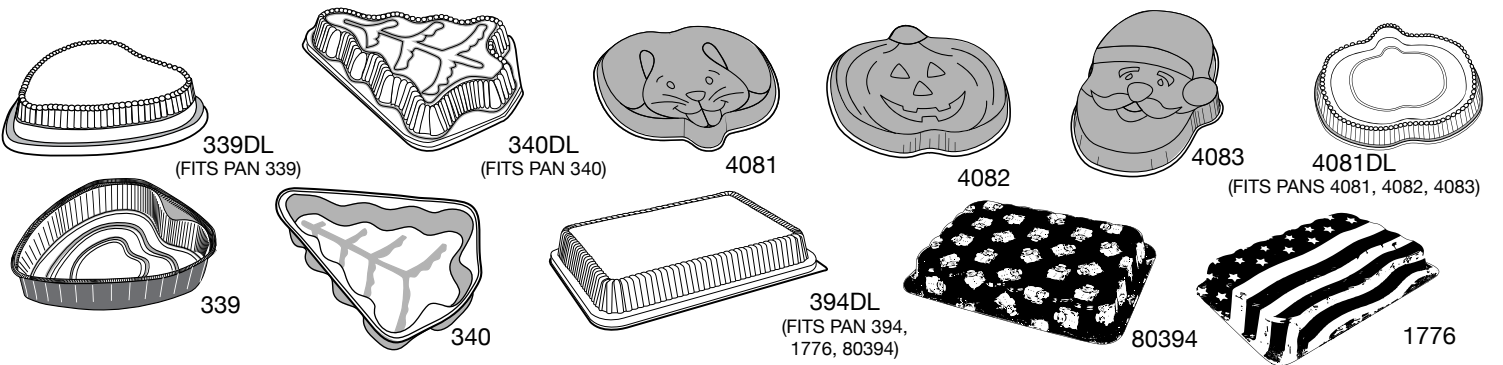

SEASONAL

ITEM #	DESCRIPTION	CAPACITY FL. Oz.	RIM STYLE	DIMENSIONS (in Inches)				CASE			
				TOP OUT	TOP IN	BOTTOM	VERTICAL DEPTH	LBS.	CUBE	PACK	
CONTAINERS											
339-30-100	Red Heart	43.0	FC	9 9/16 x 9 5/8	8 5/8 x 8 1/2	8 1/8 x 8	1 1/2	4.21	1.27	100	
340-35-100	Green Christmas Tree	36.0	FC	11 13/32 x 9 1/8	10 5/16 x 8 21/32	9 27/32 x 7 9/16	1 1/2	4.50	0.92	100	
80394-40-100	Red Oblong Snowman	116.0	FC	13 9/16 x 9 9/16	12 3/4 x 9	11 3/4 x 8	1 3/4	10.00	1.44	100	
4081-35-100	Pink Bunny	43.0	FC	10 1/16 x 8	9 3/4 x 7 1/2	9 1/2 x 7 1/8	1 1/2	5.10	1.27	100	
4082-35-100	Orange Pumpkin	43.0	FC	10 1/16 x 8	9 3/4 x 7 1/2	9 1/2 x 7 1/8	1 1/2	5.10	1.27	100	
4083-35-100	Red Santa	43.0	FC	10 1/16 x 8	9 3/4 x 7 1/2	9 1/2 x 7 1/8	1 1/2	5.10	1.27	100	
1776-40-100	Oblong Flag	108.0	FC	13 9/16 x 9 13/16	12 3/4 x 9	11 7/8 x 8 1/8	2	10.60	1.44	100	
LIDS											
339DL-100	Plastic Dome Lid for 339	—	—	9 3/8 x 9 7/8	—	—	1 1/2	4.22	1.27	100	
340DL-100	Plastic Dome Lid for 340	—	—	11 7/8 x 9 1/2	—	—	1 ¼	4.22	1.15	100	
394DL-100	Plastic Dome Lid for 394, 80394, 1776	—	—	13 3/8 x 9 15/16	—	—	1 1/2	6.40	1.09	100	
4081DL-100	Plastic Dome Lid for 4081, 4082, 4083	—	—	10 1/2 x 8 1/2	—	—	1 13/16	4.20	1.27	100	

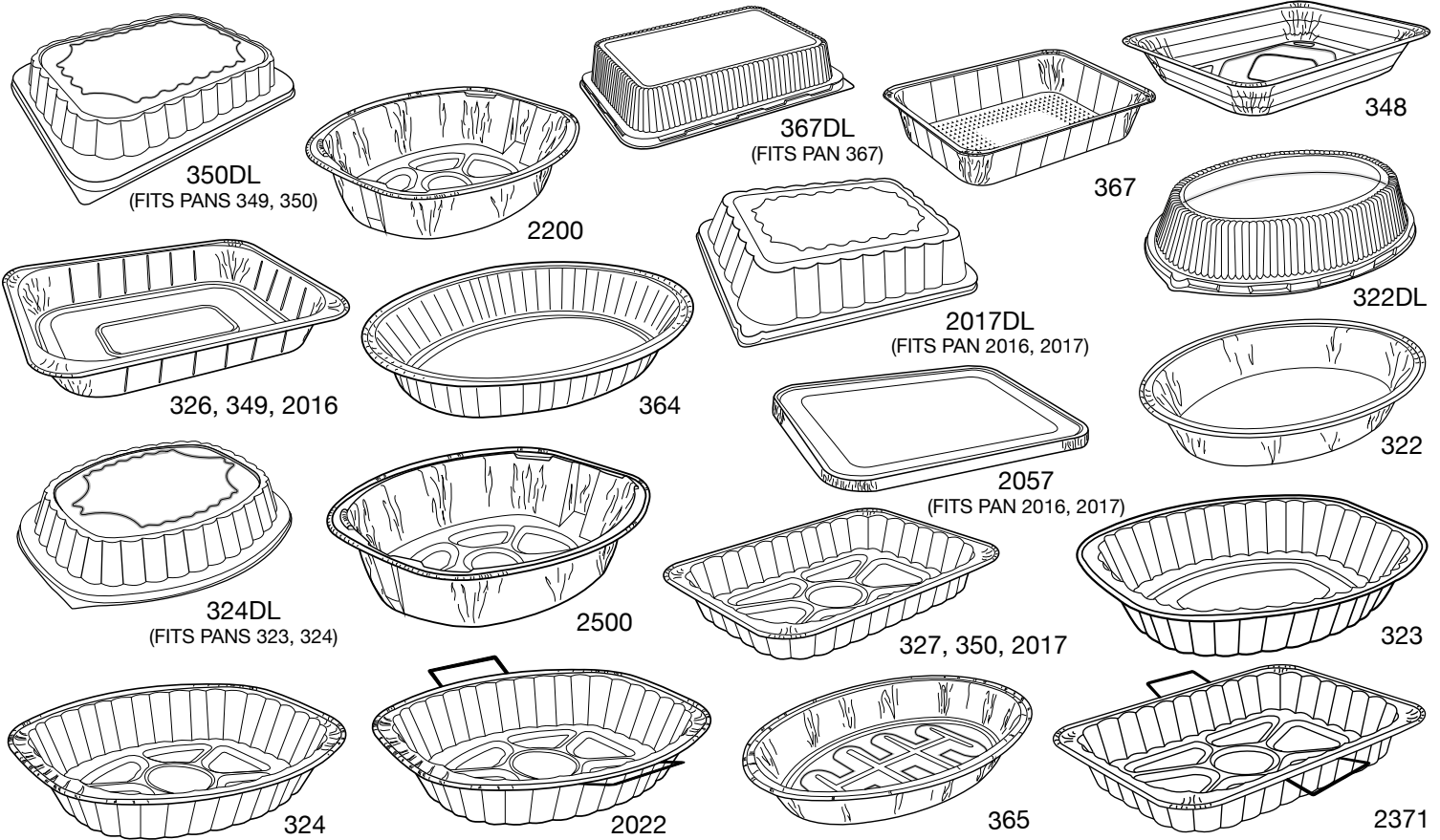

ROASTERS

ITEM #	DESCRIPTION	CAPACITY FL. OZ.	RIM STYLE	DIMENSIONS (in Inches)				CASE		
				TOP OUT	TOP IN	BOTTOM	VERTICAL DEPTH	LBS.	CUBE	PACK
CONTAINERS										
322-00-50	Oval	142.0	FC	15 x 10 5/8	14 1/16 x 9 1/16	12 1/16 x 7 1/16	3	6.50	1.34	50
323-00-100	Giant Oval	272.0	FC	17 1/16 x 14 7/16	16 x 13 1/8	13 7/8 x 11	3 1/8	22.30	4.57	100
324-00-100	Giant Oval Rack	272.0	FC	17 1/16 x 14 7/16	16 x 13 1/8	13 7/8 x 11	3 1/8	22.30	4.64	100
326-00-100	Oblong	302.0	FC	18 1/2 x 14	17 1/8 x 12 5/8	15 9/16 x 11 1/16	2 15/16	29.00	4.81	100
327-00-100	Oblong Rack	302.0	FC	18 1/2 x 14	17 1/8 x 12 5/8	15 9/16 x 11 1/16	2 15/16	29.00	4.81	100
348-00-100	Oblong	168.0	FC	16 1/4 x 11 1/16	15 3/16 x 10 5/8	13 3/4 x 9 5/16	2 1/8	20.30	2.52	100
349-00-100	Oblong	248.0	FC	18 x 13 1/4	16 5/8 x 11 7/8	15 3/8 x 10 5/8	2 5/8	21.90	4.46	100
350-00-100	Oblong Rack	240.0	FC	18 x 13 1/4	16 5/8 x 11 7/8	15 3/8 x 10 5/8	2 5/8	21.90	4.46	100
364-00-100	Oval	202.0	FC	18 x 13 1/8	16 5/8 x 11 3/4	14 3/4 x 9 3/4	2 5/8	19.40	4.46	100
365-00-100	Oval Rack	200.0	FC	18 x 13 1/8	16 5/8 x 11 3/4	14 3/4 x 9 3/4	2 5/8	19.40	4.46	100
367-50-100	Oblong	176.0	FC	14 1/2 x 10 5/8	13 1/2 x 9 5/8	12 5/16 x 8 7/16	2 15/16	15.00	2.37	100
2016-00-100	Oblong	256.0	FC	17 x 12 1/2	15 3/4 x 11 1/4	14 1/16 x 9 9/16	3 1/16	18.10	3.43	100
2017-00-100	Oblong Rack	256.0	FC	17 x 12 1/2	15 3/4 x 11 1/4	14 1/16 x 9 9/16	3 1/16	18.10	3.43	100
2022-50	Handled Giant Oval Rack	272.0	FC	17 1/16 x 14 7/16	16 x 13 1/8	13 7/8 x 11	3 1/8	24.60	3.47	50
2200-00-100	Oval	160.0	FC	13 7/8 x 11 1/4	12 5/8 x 10 1/4	10 13/16 x 8 7/16	3 1/8	15.62	2.39	100
2371-50	Handled Oblong Rack	240.0	FC	18 x 13 1/4	16 5/8 x 11 7/8	15 3/8 x 10 5/8	2 5/8	24.70	3.28	50
2500-00-100	Giant Oval CoverRoaster®	272.0	FC	17 7/8 x 14 7/16	16 x 13 1/8	13 5/16 x 11	3 1/8	26.68	4.81	100
LIDS										
2017DL-100	Plastic Dome Lid for 2017	—	—	17 x 12 1/2	—	—	2 3/4	14.00	2.58	100
2057-00-100	Foil Lid for 2017	—	IVCF	17 1/4 x 12 3/4	—	—	9/16	10.88	1.02	100
322DL-50	Dome Lid for 322, 4085	—	—	15 7/16 x 11	—	—	3	5.00	1.34	50
324DL-100	Plastic Dome Lid for 323, 324	—	—	18 3/8 x 14 7/8	—	—	3 1/8	15.00	3.47	100
350DL-100	Plastic Dome Lid for 349, 350	—	—	18 3/8 x 13 1/16	—	—	2 5/8	16.50	3.28	100
367DL-100	Plastic Dome Lid for 367	—	—	11 x 15	—	—	2 7/8	9.00	2.23	100

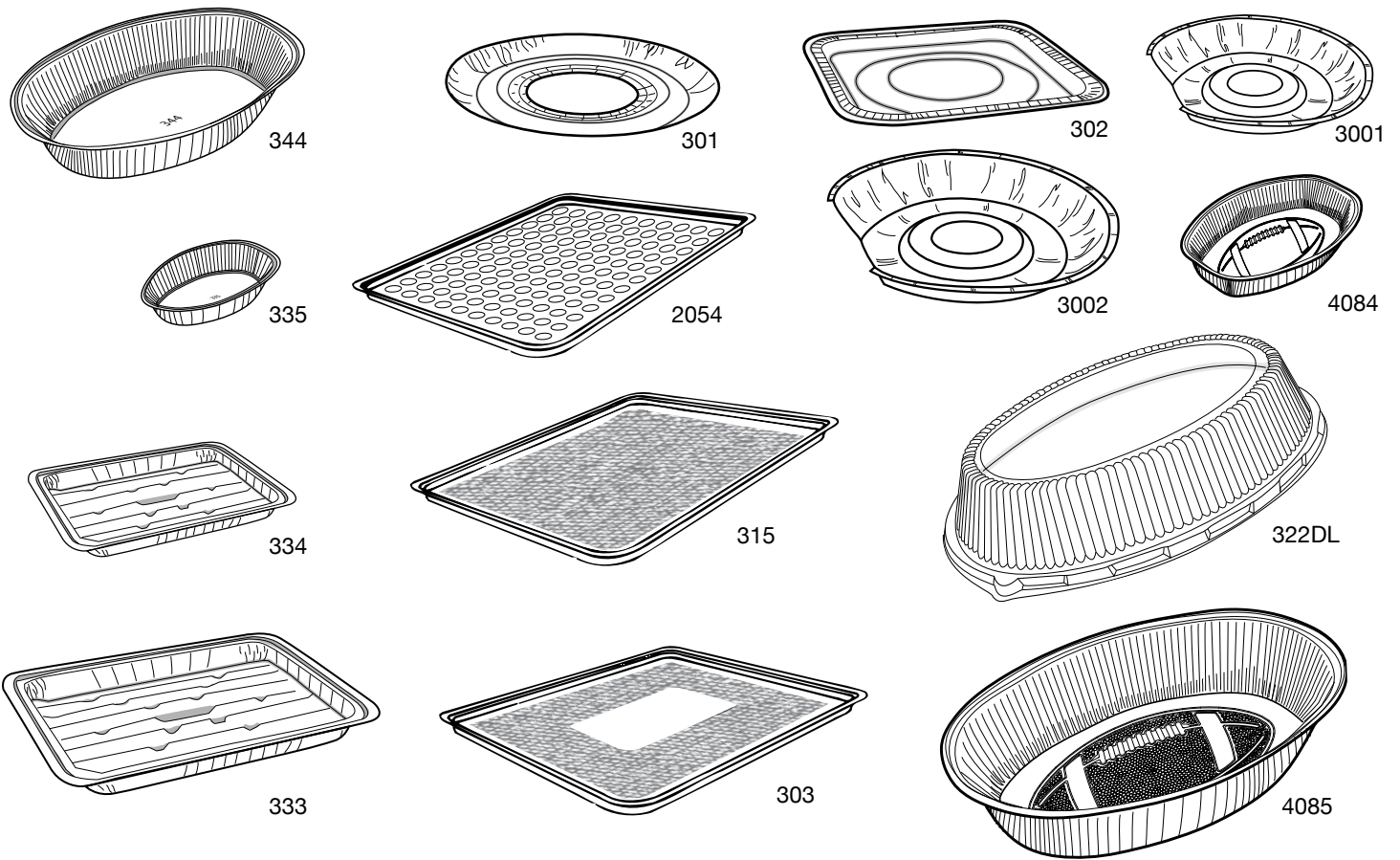

SPECIALTY

ITEM #	DESCRIPTION	CAPACITY FL Oz.	RIM STYLE	DIMENSIONS (in Inches)				CASE		
				TOP OUT	TOP IN	BOTTOM	VERTICAL DEPTH	LBS.	CUBE	PACK
CONTAINERS										
3001-30-500	Small Electric Burner Liner	—	RE	6 ³ / ₁₆	—	—	2 ³ / ₃₂	5.10	0.41	500
3002-30-500	Large Electric Burner Liner	—	RE	8	—	—	1	9.10	0.88	500
301-30-500	Round Gas Burner Liner	—	RE	7 1/2	—	—	1/2	6.52	0.50	500
301-30-1000	Round Gas Burner Liner	—	RE	7 1/2	—	—	1/2	12.96	0.96	1000
302-30-500	Square Gas Burner Liner	—	RE	8 ³ / ₁₆ x 8 ³ / ₁₆	7 1/4 x 7 1/4	6 ⁵ / ₁₆ x 6 ⁵ / ₁₆	1/2	10.50	0.49	500
302-30-1000	Square Gas Burner Liner	—	RE	8 ³ / ₁₆ x 8 ³ / ₁₆	7 1/4 x 7 1/4	6 ⁵ / ₁₆ x 6 ⁵ / ₁₆	1/2	17.00	0.84	1000
303-40-100	Oven Liner	—	FC	18 1/4 x 15 3/4	17 3/4 x 15 1/4	17 5/8 x 15 1/8	3/8	14.00	2.40	100
315-45-200	Cookie Sheet	48.0	FC	16 ³ / ₃₂ x 11 ¹ / ₁₆	15 ³ / ₃₂ x 10 ⁵ / ₁₆	14 ²⁷ / ₃₂ x 10 ¹ / ₁₆	2 ⁵ / ₃₂	22.30	5.14	200
333-35-200	Broiler	54.0	FC	13 x 9 ⁵ / ₈	11 1/2 x 8 1/2	11 1/8 x 8 1/8	1 ⁵ / ₁₆	13.30	2.59	200
334-30-200	Mini Broiler	30.0	FC	8 ³ / ₁₆ x 6 ⁷ / ₈	7 ⁷ / ₈ x 6 ³ / ₈	7 1/4 x 5 3/4	1 ¹¹ / ₃₂	6.78	1.10	200
335-20-1000	Potato Shell	2.7	FC	4 ¹¹ / ₁₆ x 2 ⁵ / ₈	4 ⁵ / ₁₆ x 2 1/4	3 ¹³ / ₁₆ x 1 3/4	3/4	5.00	0.71	1000
344-30-200	Mini Casserole	24.0	FC	8 ³ / ₁₆ x 5 ⁵ / ₈	8 x 5 1/4	7 ³ / ₁₆ x 4 ³ / ₈	1 ⁵ / ₈	5.48	1.10	200
2054-00-200	Grill Sheet	—	FC	16 ³ / ₃₂ x 11 ⁵ / ₁₆	15 ³ / ₃₂ x 10 ⁵ / ₁₆	14 ²⁷ / ₃₂ x 10 ¹ / ₁₆	2 ⁵ / ₃₂	22.00	5.14	200
4084-00-200	Small Football Pan	24.0	FC	8 ³ / ₁₆ x 5 ⁵ / ₈	8 x 5 1/4	7 ³ / ₁₆ x 4 ³ / ₈	1 ⁵ / ₈	5.70	1.10	200
4085-00-50	Large Football Pan	142.0	FC	15 x 10 ⁵ / ₈	14 ¹ / ₁₆ x 9 ¹¹ / ₁₆	12 ¹ / ₁₆ x 7 ¹¹ / ₁₆	3	6.50	1.34	50
LIDS										
322DL-50	Dome Lid for 322, 4085	—	—	15 ⁷ / ₁₆ x 11	—	—	3	5.00	1.34	50



RETAIL CATERING

ITEM #	DESCRIPTION	CAPACITY FL. OZ.	RIM STYLE	DIMENSIONS (in Inches)				CASE		
				TOP OUT	TOP IN	BOTTOM	VERTICAL DEPTH	LBS.	CUBE	PACK
CONTAINERS										
10002.010	15 Round Cake Pans	40.0	FC	9	8 1/2	7 7/8	1 7/16	6.72	1.58	12
10003.010	15 Square Cake Pans	48.0	FC	8 3/4 x 8 3/4	8 x 8	7 1/2 x 7 1/2	1 17/32	8.28	1.58	12
10004.010	15 Oblong Cake Pans	58.0	FC	12 13/16 x 8 13/16	12 1/4 x 8 1/4	11 9/16 x 7 9/16	1 1/4	12.14	2.42	12
10007.010	20 Half Size Shallow Steam Table Pans	84.0	FC	12 3/4 x 10 3/8	11 3/4 x 9 3/8	10 13/16 x 8 7/16	1 11/16	14.82	4.94	12
10008.010	20 Half Size Deep Steam Table Pans	128.0	FC	12 3/4 x 10 3/8	11 3/4 x 9 3/8	10 1/4 x 7 7/8	2 9/16	18.60	4.94	12
10010-6	10 Full Size Deep Steam Table Pans	343.0	FC	20 3/4 x 12 13/16	19 9/16 x 11 5/8	17 3/4 x 9 13/16	3 3/16	20.58	2.99	6
10011.010	10 Full Size Shallow Steam Table Pans	176.0	FC	20 3/4 x 12 3/4	19 5/8 x 11 3/4	18 5/8 x 10 3/4	1 5/8	32.80	4.94	12
10012.010	10 Half Size Deep Steam Table Pans	128.0	FC	12 3/4 x 10 3/8	11 3/4 x 9 3/8	10 1/4 x 7 7/8	2 9/16	12.20	2.33	12
10013.010	10 Half Size Shallow Steam Table Pans	84.0	FC	12 3/4 x 10 3/8	11 3/4 x 9 3/8	10 13/16 x 8 7/16	1 11/16	9.70	2.33	12
10014.010	10 Half Size Steam Table Lids	—	IVCF	12 13/16 x 10 7/16	—	—	5/8	6.80	1.15	12
10015.010	10 Full Size Steam Table Lids	—	IVCF	20 13/16 x 12 7/8	—	—	5/8	18.00	2.33	12
10016.010	5 - 12" Round Serving Trays	—	FC	12	11 1/4	10	9/16	9.50	1.01	12
10017.010	5 - 16" Round Serving Trays	—	FC	16	16 1/4	14	13/16	16.00	1.31	12
10018.010	5 - 18" Round Serving Trays	—	FC	18	18 1/4	16	15/16	23.70	2.13	12
10019-6	5 - 12" Round Dome Lids for 10016, 10022	—	—	12	—	—	2 1/2	4.00	1.36	6
10020-6	5 - 16" Round Dome Lids for 10017, 10023	—	—	16	—	—	2 1/2	7.20	2.40	6
10021-6	5 - 18" Round Dome Lids for 10018, 10024	—	—	18	—	—	2 1/2	9.90	3.32	6
10022-6	5 - 12" Black Plastic Round Serving Tray	—	—	12	10 5/8	10	15/16	5.70	1.01	6
10023-6	5 - 16" Black Plastic Round Serving Tray	—	—	16	14 5/8	14	15/16	10.80	1.31	6
10024-6	5 - 18" Black Plastic Round Serving Tray	—	—	18	16 5/8	16	15/16	12.08	2.13	6



12": 1225, 1230, 1250, 1275, 12200, 12250
 18": 1837, 1838, 1875



12": 910, 912
 18": 924



20547CM

RETAIL ROLL FOIL



ITEM#	SIZE	STYLE	CASE PACK	WEIGHT PER CASE (LBS.)	CUBE PER CASE	ITEM UPC
HANDI-FOIL®						
1225	12" x 25' (25 sq. ft)	STANDARD	24	8.4	0.54	01225-6
1230	12" x 30' (30 sq. ft)	STANDARD	24	9.0	0.54	01230-0
1250	12" x 50' (50 sq. ft)	HEAVY DUTY	24	19.0	0.54	01250-8
1275	12" x 75' (75 sq. ft)	STANDARD	24	19.10	0.54	01275-1
12200	12" x 200' (200 sq. ft)	STANDARD	12	24.1	0.46	12200-9
12250	12" x 250' (250 sq. ft)	STANDARD	12	29.0	0.46	12250-4
1837	18" x 25' (37.5 sq. ft)	HEAVY DUTY	24	17.0	0.79	01837-1
1838	18" x 25' (37.5 sq. ft)	BBQ GRILL FOIL	24	17.0	0.79	01838-8
1875	18" x 50' (75 sq. ft)	HEAVY DUTY	24	28.0	0.79	01875-3
JIFFY-FOIL®						
910	12" x 20' (20 sq. ft)	STANDARD	50	14.2	1.12	00910-9
912	12" x 40' (40 sq. ft)	STANDARD	50	26.6	1.12	00912-3
924	18" x 20' (30 sq. ft)	HEAVY DUTY	24	11.0	0.79	00924-6
WRAP-UPS®						
20547CM	26 - 12" x 10 3/4" Pre-Cut Foil Pop-Up Foil Sheets	—	24	8.27	1.13	20547-4



INDEX BY ITEM NUMBER

301	ROUND GAS BURNER LINER	18	2012DL	PLASTIC DOME LID FOR 2012, 2013,6751	9
302	SQUARE GAS BURNER LINER	18	2013	16" ROUND SERVING TRAY	9
303	OVEN LINER	18	2014	½ SIZE STEAM TABLE - EXTRA DEEP	7
304	9" PIE	14	2016	OBLONG	17
304P	9" PERFORATED PIE	14	2017	OBLONG RACK	17
305	10" PIE	14	2017DL	PLASTIC DOME LID FOR 2017	17
305P	10" PERFORATED PIE	14	2019	FULL SIZE STEAM TABLE - DEEP	7
306	5" TART	14	2019ECO	FULL SIZE STEAM TABLE - DEEP 100% RECYCLED ALUMINUM	7
307	9" ROUND	13	2019LDL	LOW DOME LIDS FOR 2019, 4020, 4021	7
307DL	PLASTIC DOME LID FOR 307	13	2019HDL	HIGH DOME LIDS FOR 2019, 4020, 4021	7
308	9" SQUARE CAKE	15	2022	HANDLED GIANT OVAL RACK CONTAINER	17
308DL	PLASTIC DOME LID FOR 308, 80396	15	2035	EMBOSSED SERVING TRAY	9
309	¼ SIZE SHEET CAKE	16	2045	OBLONG 3-COMPARTMENT TRAY	6
309DL	PLASTIC DOME LID FOR 309	16	2046	9" ROUND	13
309HDL	PLASTIC HIGH DOME LID FOR 309	16	2046DL	PLASTIC DOME LID FOR 2046	13
309LDL	PLASTIC LOW DOME LID FOR 309	16	2046L	FOIL LAMINATED BOARD LID FOR 2046	13
310	OBLONG	13	2047	7" ROUND	13
312	OBLONG	13	2047DL	PLASTIC DOME LID FOR 2047	13
315	COOKIE SHEET	18	2047L	FOIL LAMINATED BOARD LID FOR 2047	13
316	2 LB LOAF	11	2049	FOIL LID FOR 320, 321, 2014, 4022, 4025	7
316DL	PLASTIC DOME LID FOR 316	11	2049P	VENTED FOIL LID FOR 320, 321, 2014, 4022, 4025	7
317	1 LB LOAF	11	2050	FOIL LID FOR 2019, 4020, 4021	7
317DL	PLASTIC DOME LID FOR 317	11	2054	GRILL SHEET	18
318	½ SIZE STEAM TABLE	7	2057	FOIL LID FOR 2017	17
319	12" PIZZA	13	2058	8" ROUND	13
320	½ SIZE STEAM TABLE - SHALLOW	7	2058DL	PLASTIC DOME LID FOR 2058	13
321	½ SIZE STEAM TABLE - DEEP	7	2058L	FOIL LAMINATED BOARD LID FOR 2058	13
321ECO	½ SIZE STEAM TABLE - DEEP 100% RECYCLED ALUMINUM	7	2059	1 LB OBLONG	11
321HDL	½ SIZE STEAM HIGH DOME LID FOR 320,321,2014,4022,4025	7	2059DL	PLASTIC DOME LID FOR 2059	11
321LDL	½ SIZE STEAM LOW DOME LID FOR 320,321,2014,4022,4025	7	2059L	FOIL LAMINATED BOARD LID FOR 2059	11
322	OVAL	17	2060	1 ½ LB OBLONG	11
322DL	DOME LID FOR 322, 4085	18	2060DL	PLASTIC DOME LID FOR 2060	11
323	GIANT OVAL	17	2060L	FOIL LAMINATED BOARD LID FOR 2060	11
324	GIANT OVAL RACK	17	2061	1 ½ LB OBLONG - SHALLOW	11
324DL	PLASTIC DOME LID FOR 323,324	17	2062	2 ¼ LB OBLONG	11
326	OBLONG	17	2062DL	PLASTIC DOME LID FOR 2061, 2062, 4032	11
327	OBLONG RACK	17	2062L	FOIL LAMINATED BOARD LID FOR 2061, 2062, 4032	11
329	OBLONG DANISH	13	2063	½ SIZE SHEET CAKE	16
333	BROILER	18	2063DL	PLASTIC DOME LID FOR 2063	16
334	MINI BROILER	18	2036HDL	PLASTIC HIGH DOME LID FOR 2063	16
335	POTATO SHELL	18	2063LDL	PLASTIC LOW DOME LID FOR 2063	16
339	RED HEART	16	2064	FULL SIZE SHEET CAKE	16
339DL	PLASTIC DOME LID FOR 339	16	2111	DEEP UTILITY PAN	15
340	GREEN CHRISTMAS TREE	16	2111DL	PLASTIC DOME LID FOR 2111	15
340DL	PLASTIC DOME LID FOR 340	16	2200	OVAL	17
341	4 OZ CUP	13	2371	HANDLED OBLONG RACK	17
344	MINI CASSEROLE	18	2500	GIANT OVAL COVER CONTAINER	17
348	OBLONG ROASTER	17	3001	SMALL ELECTRIC BURNER LINER	18
349	OBLONG	17	3002	LARGE ELECTRIC BURNER LINER	18
350	OBLONG RACK	17	4001	11" EXTRA DEEP PIE	14
350DL	PLASTIC DOME LID FOR 349, 350	17	4002	8" PIE	14
355	MUFFIN PAN - 6 CAVITY	14	4002P	8" PERFORATED PIE	14
363	2 ¼ LB OBLONG	11	4003	12" PIE	14
364	OVAL	17	4003P	12" PERFORATED PIE	14
365	OVAL RACK	17	4004	9" EXTRA DEEP PIE	14
367	OBLONG	17	4004P	9" EXTRA DEEP PERFORATED PIE	14
367DL	PLASTIC DOME LID FOR 367	17	4005	8" EXTRA DEEP PIE	14
394	OBLONG	15	4005P	8" EXTRA DEEP PERFORATED PIE	14
394DL	PLASTIC DOME LID FOR 394, 80394	15 & 16	4006	6" PIE	14
910	12" X 20' STD JIFFY-FOIL ROLL FOIL	20	4007	POT PIE	14
912	12" X 40' STD JIFFY-FOIL ROLL FOIL	20	4007DL	PLASTIC DOME LID FOR 4007	14
924	18" X 20' HD JIFFY-FOIL ROLL FOIL	20	4010	10" MEDIUM PIE	14
1225	12" X 25' STD HANDI-FOIL ROLL FOIL	20	4012	12" LAZY SUSAN	9
1230	12" X 30' STD HANDI-FOIL ROLL FOIL	20	4012DL	PLASTIC DOME LID FOR 4012, 4013, 6750	9
1250	12" X 50' HD HANDI-FOIL ROLL FOIL	20	4013	12" ROUND SERVING TRAY	9
1275	12" X 75' STD HANDI-FOIL ROLL FOIL	20	4018	18" LAZY SUSAN	9
12200	12" X 200' STD HANDI-FOIL ROLL FOIL	20	4018DL	PLASTIC DOME LID FOR 4018, 4019, 6752	9
1776	FLAG PAN	16	4018HDL	PLASTIC HIGH DOME LID FOR 4018, 4019, 6752	9
1837	18" X 25' HD HANDI-FOIL ROLL FOIL	20	4019	18" ROUND SERVING TRAY	9
1838	18" X 25' HD BBQ GRILL FOIL	20	4020	FULL SIZE STEAM TABLE - MEDIUM	7
1875	18" X 50' HD HANDI-FOIL ROLL FOIL	20	4021	FULL SIZE STEAM TABLE - SHALLOW	7
2012	16" LAZY SUSAN	9	4022	½ SIZE CONTOURED STEAM TABLE - DEEP	7

Continued on next page

4025	½ SIZE STEAM TABLE - MEDIUM	7	6051S	HANDI-LOCK 5" SQUARE CONTAINER SHALLOW	6
4030	FOIL LID FOR 318, 4035	7	6051D	HANDI-LOCK 5" SQUARE CONTAINER DEEP	6
4031	SQUARE POULTRY	15	6061D	HANDI-LOCK 6" SQUARE CONTAINER DEEP	6
4031DL	PLASTIC DOME LID FOR 4031	15	6091S	HANDI-LOCK 9" SQUARE CONTAINER SHALLOW	6
4032	2 LB CARRYOUT	11	6091D	HANDI-LOCK 9" SQUARE CONTAINER DEEP	6
4035	TRU-FIT™ ½ SIZE STEAM TABLE	7	6093S	HANDI-LOCK 9" x 9" 3 COMPARTMENT CONTAINER SHALLOW	6
4040	4 LB OBLONG	11	6010S	HANDI-LOCK 10" CONTAINER SHALLOW	6
4040DL	PLASTIC DOME LID FOR 4040	11	6013S	HANDI-LOCK 10" 3 COMPARTMENT CONTAINER SHALLOW	6
4040L	FOIL LAMINATED BOARD LID FOR 4040	11	6750	12" BLACK PLASTIC ROUND SERVING TRAY	9
4041	5 LB OBLONG	11	6751	16" BLACK PLASTIC ROUND SERVING TRAY	9
4041L	FOIL LAMINATED BOARD LID FOR 4041	11	6752	18" BLACK PLASTIC ROUND SERVING TRAY	9
4043	1 ½ LB LOAF	11	10002	CATERING ESSENTIALS 15 ROUND CAKE PANS	19
4044	1 ½ LB LOAF	11	10003	CATERING ESSENTIALS 15 SQUARE CAKE PANS	19
4044DL	PLASTIC DOME LID FOR 4044	11	10004	CATERING ESSENTIALS 15 OBLONG CAKE PANS	19
4044L	FOIL LAMINATED BOARD LID FOR 4044	11	10007	CATERING ESSENTIALS 20 HALF SIZE SHALLOW STEAM TABLE PANS	19
4045	2 LB OBLONG	11	10008	CATERING ESSENTIALS 20 HALF SIZE DEEP STEAM TABLE PANS	19
4045DL	PLASTIC DOME LID FOR 2045, 4045	11	10010	CATERING ESSENTIALS 10 FULL SIZE DEEP STEAM TABLE PANS	19
4045L	FOIL LAMINATED BOARD LID FOR 2045, 4045	11	10011	CATERING ESSENTIALS 10 FULL SIZE SHALLOW STEAM TABLE PANS	19
4046	3 LB OBLONG	11	10012	CATERING ESSENTIALS 10 HALF SIZE DEEP STEAM TABLE PANS	19
4046L	FOIL LAMINATED BOARD LID FOR 4046	11	10013	CATERING ESSENTIALS 10 HALF SIZE SHALLOW STEAM TABLE PANS	19
4048	8" SQUARE CAKE	15	10014	CATERING ESSENTIALS 10 HALF SIZE STEAM TABLE LIDS	19
4048DL	PLASTIC DOME LID FOR 4048	15	10015	CATERING ESSENTIALS 10 FULL SIZE STEAM TABLE LIDS	19
4050	10" ROUND	13	10016	CATERING ESSENTIALS 5 - 12" ROUND SERVING TRAYS	19
4050DL	PLASTIC DOME LID FOR 4050	13	10017	CATERING ESSENTIALS 5 - 16" ROUND SERVING TRAYS	19
4050L	FOIL LAMINATED BOARD LID FOR 4050	13	10018	CATERING ESSENTIALS 5 - 18" ROUND SERVING TRAYS	19
4051	OBLONG CAKE	15	10019	CATERING ESSENTIALS 5 - 12" ROUND DOME LIDS FOR 10016, 10022	19
4053	OBLONG DANISH	13	10020	CATERING ESSENTIALS 5 - 16" ROUND DOME LIDS FOR 10017, 10023	19
4053HT	HINGED PLASTIC DOME FOR 4053	13	10021	CATERING ESSENTIALS 5 - 18" ROUND DOME LIDS FOR 10018, 10024	19
4055	MUFFIN PAN - 4 CAVITY	14	10022	CATERING ESSENTIALS 5 - 12" BLACK PLASTIC ROUND SERVING TRAY	19
4056	MUFFIN PAN - 12 CAVITY	14	10023	CATERING ESSENTIALS 5 - 16" BLACK PLASTIC ROUND SERVING TRAY	19
4060	8" ANGEL FOOD PAN W/CUP	15	10024	CATERING ESSENTIALS 5 - 18" BLACK PLASTIC ROUND SERVING TRAY	19
4060DL	PLASTIC DOME LID FOR 4060, 4061	15	11203	12" X 1000' STD MEDALLION FOOD SERVICE ROLL FOIL	4
4061	8" ROUND BAKING PAN - DEEP	15	11205	12" X 1000' STD HANDI-FOIL FOOD SERVICE ROLL FOIL	4
4062	3 ½ OZ CUP	13	11505	15" X 1000' STD HANDI-FOIL FOOD SERVICE ROLL FOIL	4
4062DL	PLASTIC DOME LID FOR 341, 4062	13	11803	18" X 1000' STD MEDALLION FOOD SERVICE ROLL FOIL	4
4063	10" ANGEL FOOD PAN W/CUP	15	11805	18" X 1000' STD HANDI-FOIL FOOD SERVICE ROLL FOIL	4
4063DL	PLASTIC DOME LID FOR 4063, 4064	15	11807	18" X 1000' HD MEDALLION FOOD SERVICE ROLL FOIL	4
4064	10" ROUND BAKING PAN - DEEP	15	11808	18" X 1000' HD HANDI-FOIL FOOD SERVICE ROLL FOIL	4
4071	9" ROUND	13	12408	24" X 1000' HD HANDI-FOIL FOOD SERVICE ROLL FOIL	4
4072	7" ROUND-SLIM	13	20547CM	12" X 10 ¾" WRAP-UP PRECUT POP-UP FOIL SHEETS - 25	20
4072DL	PLASTIC DOME LID FOR 4072	13	21205	12" X 2000' STD HANDI-FILM FOOD SERVICE FILM	5
4072L	FOIL LAMINATED BOARD LID FOR 4072	13	21205-S	12" X 2000' SC HANDI-FILM FOOD SERVICE FILM	5
4081	PINK BUNNY PAN	16	21210	12" X 10 ¾" INTERFOLDED FOIL SHEETS - 200	5
4081DL	PLASTIC DOME LID FOR 4081, 4082, 4083	16	21210ECO	12" X 10 ¾" INTERFOLDED FOIL SHEETS - 200 100% RECYCLED ALUM	5
4082	ORANGE PUMPKIN PAN	16	21215	12" X 10 ¾" INTERFOLDED FOIL SHEETS - 200	5
4083	RED SANTA PAN	16	21805	18" X 2000' STD HANDI-FILM FOOD SERVICE FILM	5
4084	SMALL FOOTBALL PAN	16	21805-S	18" X 2000' SC HANDI-FILM FOOD SERVICE FILM	5
4085	LARGE FOOTBALL PAN	16	22405	24" X 2000' STD HANDI-FILM FOOD SERVICE FILM	5
4100	HOT DOG SCHOOL TRAY	6	22405-S	24" X 2000' SC HANDI-FILM FOOD SERVICE FILM	5
4101	HAMBURGER SCHOOL TRAY	6	29100	9" X 10 ¾" INTERFOLDED FOIL SHEETS - 200	5
4102	1 LB SHALLOW OBLONG TRAY	6	29110	9" X 10 ¾" GOLD INTERFOLDED FOIL SHEETS - 200	5
4103	1 LB DEEP OBLONG TRAY	6	51205	12" X 500' STD HANDI-FOIL FOOD SERVICE ROLL FOIL	4
4201	GOURMET-TO-GO SMALL ENTREE	9	51207	12" X 500' HD MEDALLION FOOD SERVICE ROLL FOIL	4
4201DL	PLASTIC DOME LID FOR 4201	9	51208	12" X 500' HD HANDI-FOIL FOOD SERVICE ROLL FOIL	4
4202	GOURMET-TO-GO MEDIUM ENTREE	9	51210	12" X 10 ¾" INTERFOLDED FOIL SHEETS - 500	5
4203	GOURMET-TO-GO LARGE ENTREE	9	51210GOLD	12" X 10 ¾" INTERFOLDED FOIL SHEETS GOLD - 500	5
4203DL	PLASTIC DOME LID FOR 4203	9	51215	12" X 10 ¾" INTERFOLDED FOIL SHEETS - 500	5
4204	GOURMET-TO-GO RECTANGULAR ENTREE	9	51508	15" X 500' HD HANDI-FOIL FOOD SERVICE ROLL FOIL	4
4205	GOURMET-TO-GO SMOOTHWALL ENTREE	9	51803	18" X 500' STD MEDALLION FOOD SERVICE ROLL FOIL	4
4205DL	PLASTIC DOME LID FOR 4205	9	51805	18" X 500' STD HANDI-FOIL FOOD SERVICE ROLL FOIL	4
4207	GOURMET-TO-GO GRILL PAN	9	51807	18" X 500' HD MEDALLION FOOD SERVICE ROLL FOIL	4
4208	GOURMET-TO-GO SQUARE CAKE	9	51808	18" X 500' HD HANDI-FOIL FOOD SERVICE ROLL FOIL	4
4209	GOURMET-TO-GO 1/2 SIZE STEAM TABLE	9	51809	18" X 500' XHD ROLL FOIL	4
4210	GOURMET-TO-GO RECTANGULAR ROASTER	9	52408	24" X 500' HD HANDI-FOIL FOOD SERVICE ROLL FOIL	4
4211	GOURMET-TO-GO ROUND	9	57100	7" X 10 ¾" INTERFOLDED FOIL SHEETS - 500	5
4212	GOURMET-TO-GO LOAF	9	58100	8" X 10 ¾" INTERFOLDED FOIL SHEETS - 500	5
4213	GOURMET-TO-GO ROASTER	9	59100	9" X 10 ¾" INTERFOLDED FOIL SHEETS - 500	5
4214	GOURMET-TO-GO PIE PAN	9	59100RED	9" X 10 ¾" INTERFOLDED FOIL SHEETS RED STRIPE - 500	5
4215	GOURMET-TO-GO SMALL OBLONG	9	59100BLUE	9" X 10 ¾" INTERFOLDED FOIL SHEETS BLUE STRIPE - 500	5
4216	LARGE ENTREE - SILVER	9	59100GREEN	9" X 10 ¾" INTERFOLDED FOIL SHEETS GREEN STRIPE - 500	5
4216DL	PLASTIC DOME LID FOR 4216	9	80394	RECTANGLE SNOWMAN	16